

ASSEMBLY INSTRUCTION

GROUP NO: GROUP NO: SH3187





ITEM NO : SH3187PNK-3 / SH3187PNK-4 / SH3187PNK-5

Thank you for purchasing this product. Please take time to read and follow the instructions below. Check that you have all parts and hardware before assembly. Parts apparently missing are often found in the packing materials. If you do not have all the parts listed, have your dealer contact us and they be sent to you immediately.







▲ It is recommended to install protective pads under all legs and supports to avoid damage or scratches when placing furniture on a wood floor or other hard surface, and to limit indentation and prevent discoloration if placing on carpet.

NOTE: Do not use power tools for assembly. Power tools increase the risk of over tightening which lead to splitting or cracking the wood.

HARDWARE FOR SH3187 PNK- 5







NO	DESCRIPTION	SKETCH	SIZE	QTY
1	Threaded		1/4*100mm	6 pcs
2	Washer		1/4*2mm	6 pcs
3	Hexnut		1/4* 4.5mm	6 pcs
4	Wrench		1/4	1 pc

HARDWARE FOR SH3187 PNK- 3 SOFA



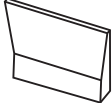
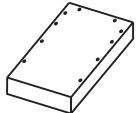

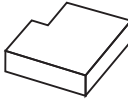

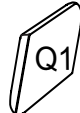
NO	DESCRIPTION	SKETCH	SIZE	QTY
1	Threaded		1/4*100mm	4 pcs
2	Washer		1/4*2mm	4 pcs
3	Hexnut		1/4*6mm	4 pcs
5	Threaded		5/16*80mm	5 pcs
6	Washer		5/16*2mm	5 pcs
7	Hexnut		5/16* 6mm	5 pcs
8	Wrench		5/16	1 pc

BOTH HARDWARE ARE PACK INTO #SH3187PNK-3

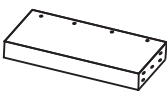
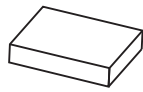

PARTS LIST FOR SH3187 PNK-5 CHAISE

NO	DESCRIPTION	DRAWING	Part No.	QTY
1	Backrest		A1	1 pc
2	Backrest		A2	1 pc
3	Backrest		A3	1 pc
4	Frame		A4	1 pc
5	Cushion		A5	1 pc
6	L-Cushion		A6	1 pc
7	Leg		L1	4 pcs
8	Pillow		PNK	2 pcs
			Grey	1 pc

PARTS LIST FOR SH3187 PNK-3 SOFA

NO	DESCRIPTION	DRAWING	Part No.	QTY
1	Backrest		B1	1 pc
2	Armrest		B2	1 pc
3	Frame		B3	1 pc
4	Cushion		B4	2 pcs
5	Leg		L1	4 pcs
6	Pillow		PNK	2 pcs
			Grey	2 pcs
7	Feather pillow		White	2pcs

PARTS LIST FOR SH3187 PNK - 4 Ottoman

1	Leg		L1	4 pcs
2	Ottoman top		N1	1pc
3	Ottoman base		N2	1pc

ASSEMBLY INSTRUCTIONS TYPE 1

Take out the Legs and Hardware in the bag to assembly

ASSEMBLY BLOCK A

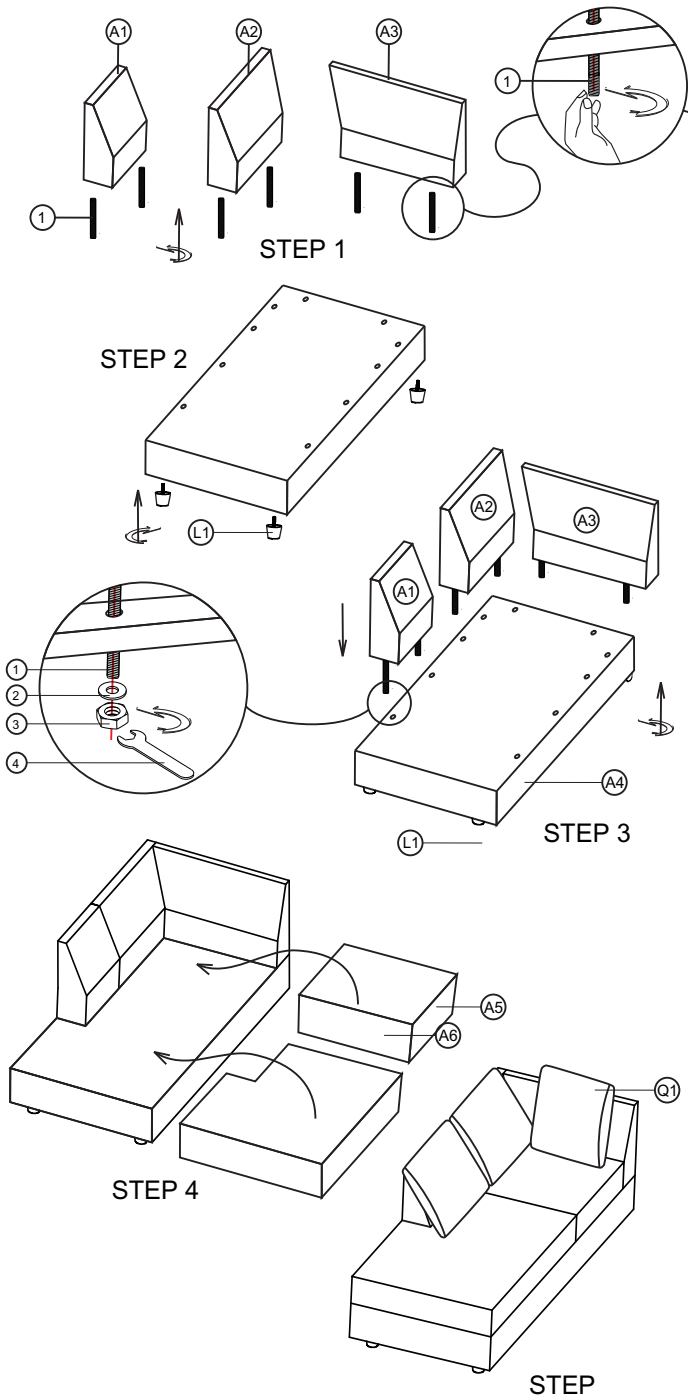

ASSEMBLY BLOCK B

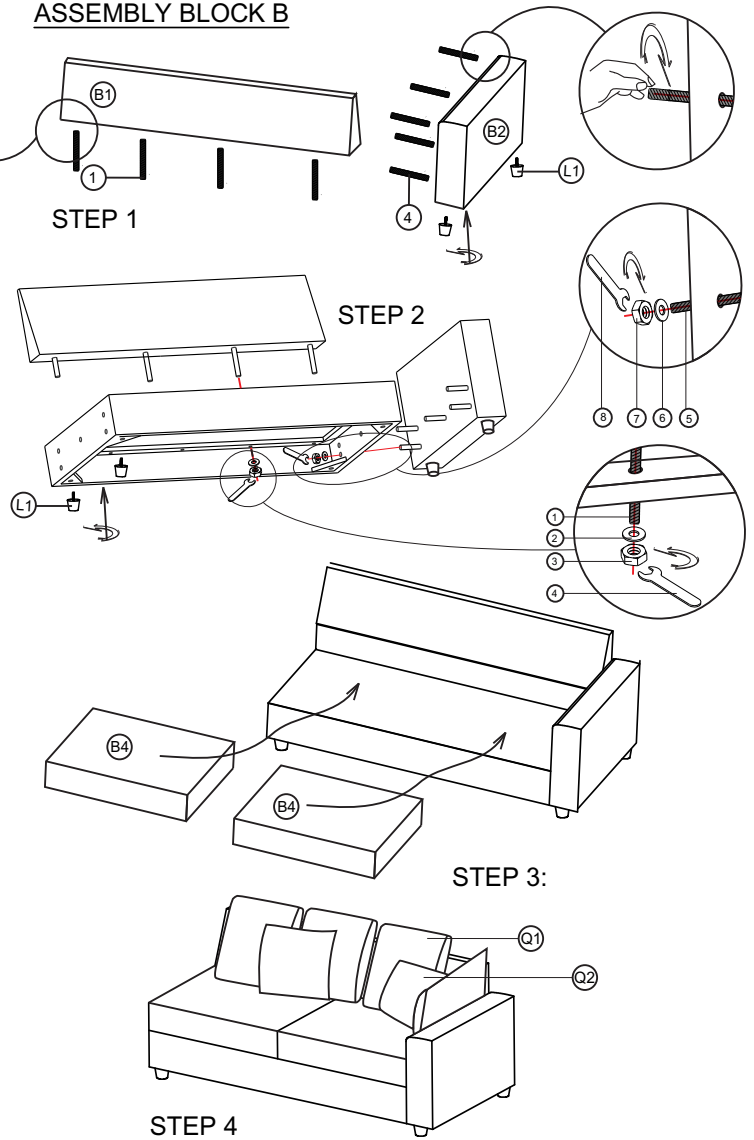

ASSEMBLY BLOCK C

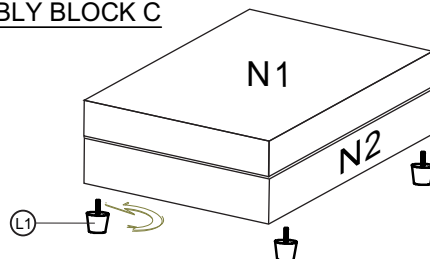

Assembly COMPLETED

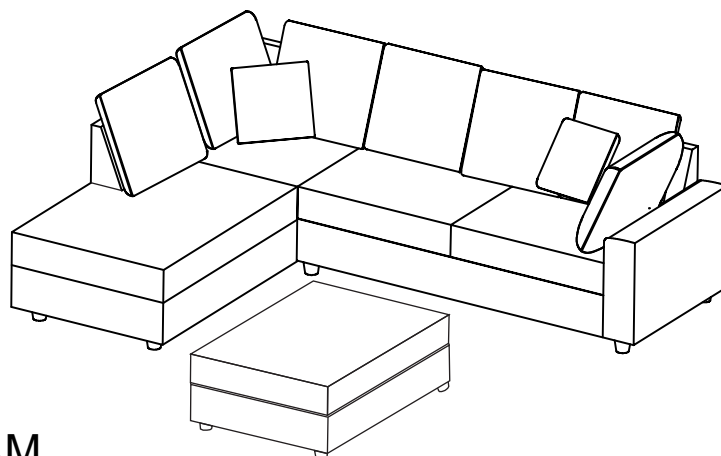

ASSEMBLY INSTRUCTIONS TYPE 2

Take out the Legs and Hardware in the bag to assembly

ASSEMBLY BLOCK A

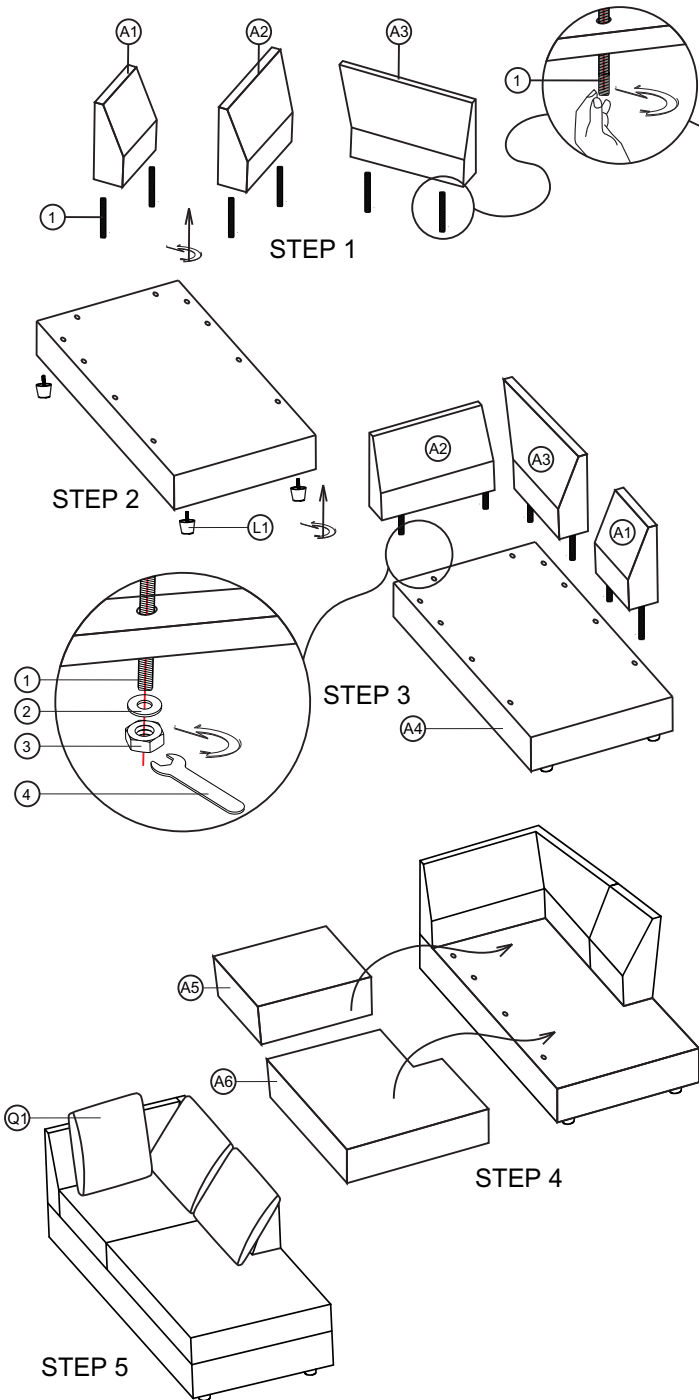

ASSEMBLY BLOCK B

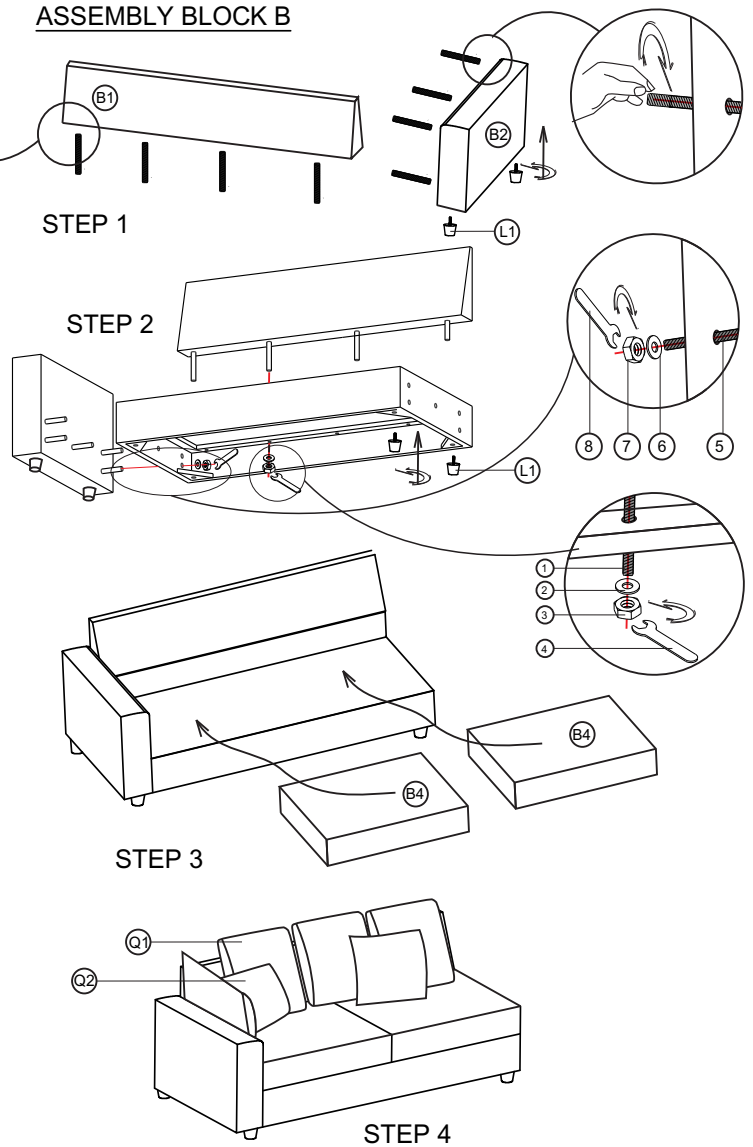

ASSEMBLY BLOCK C

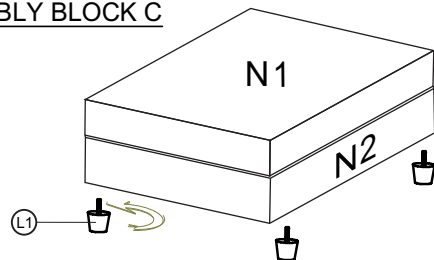

Assembly COMPLETED

