

Assembly Instructions

ITEM: SH3413

Sofa Power with power headrest
Love Seat w/console
Power Recliner with power headrest

SKU:

SH3413SAD-3PWH

SH3413SAD-2PWH

SH3413SAD-1PWH

SH3413GRY-3PWH

SH3413GRY-2PWH

SH3413GRY-1PWH

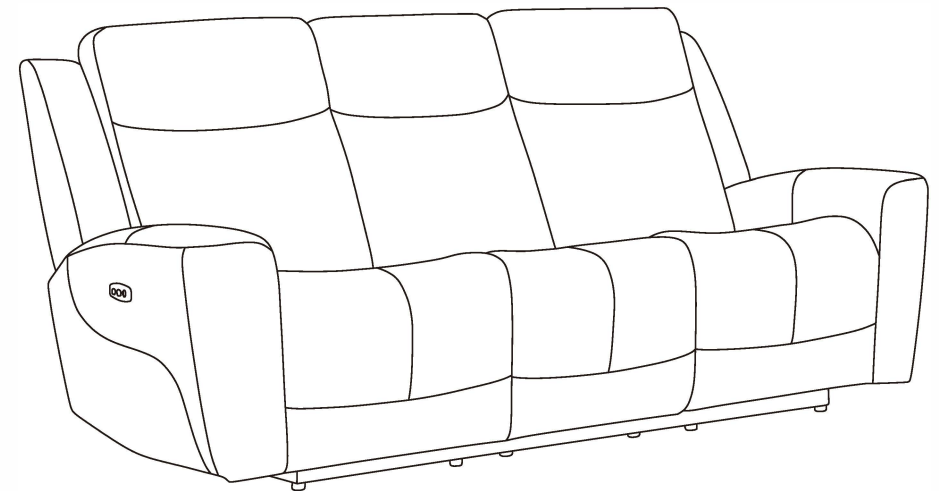
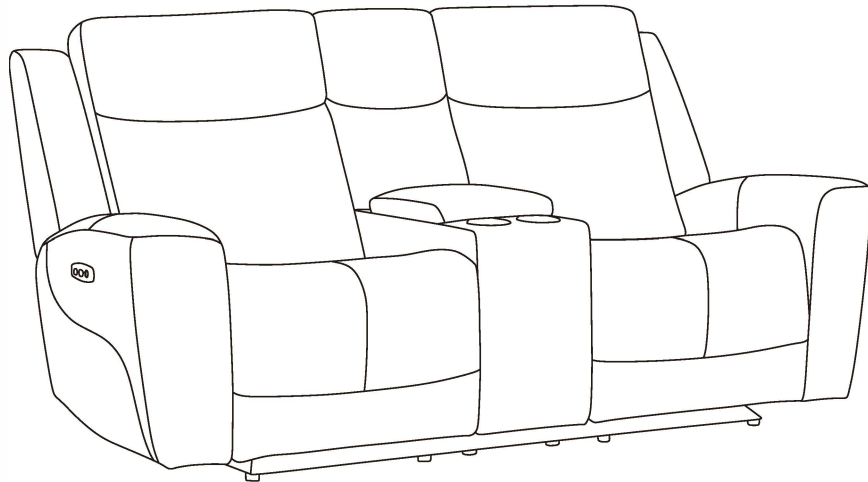
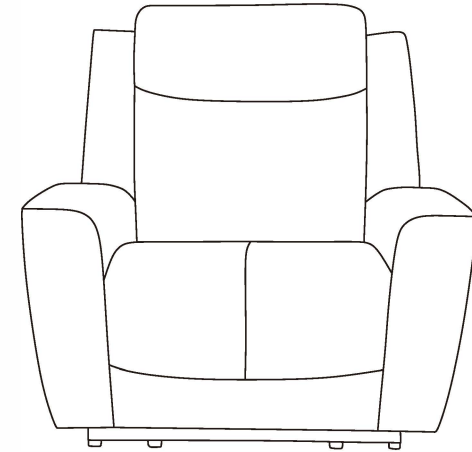

Preparations

Pre-Assembly Preparations

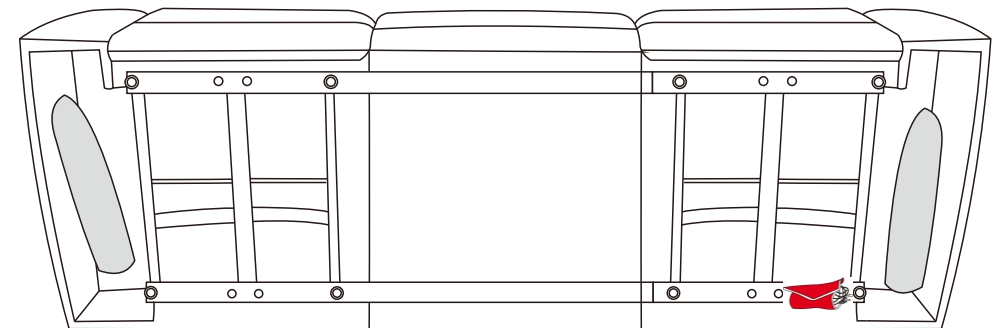
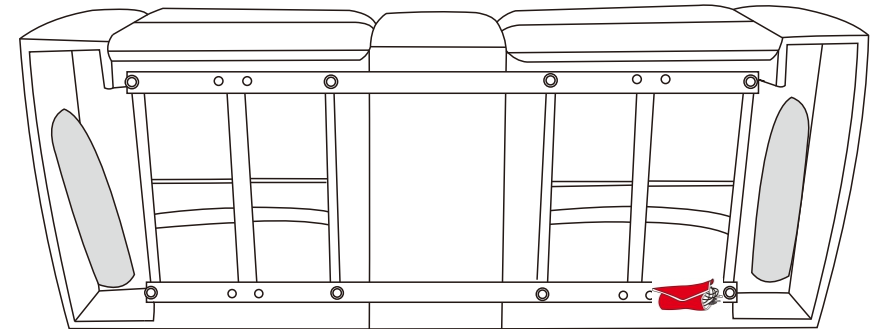
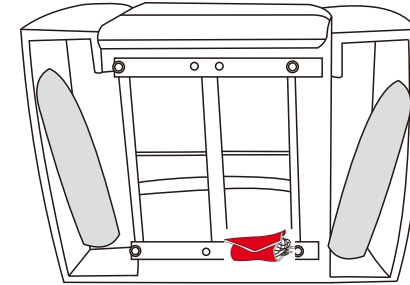

Thank you for choosing our product, please read this instruction carefully before assembly.

First, to avoid damage to the product, please make sure you have a large and clean place to assemble. Second, please check all the parts according to the list on the next page.

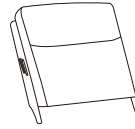

List of Parts

PART LIST

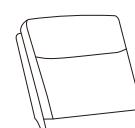
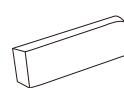
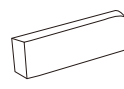
NO	Sketch	Description	Quantity Recliner	Quantity Loveseat	Quantity Sofa
A		BACK	1		
B		BACK(L)		1	1
C		BACK (Console)		1	
D		BACK(R)		1	1
E		BACK(M)			1
G		Wing (L)	1	1	1
H		Wing (R)	1	1	1

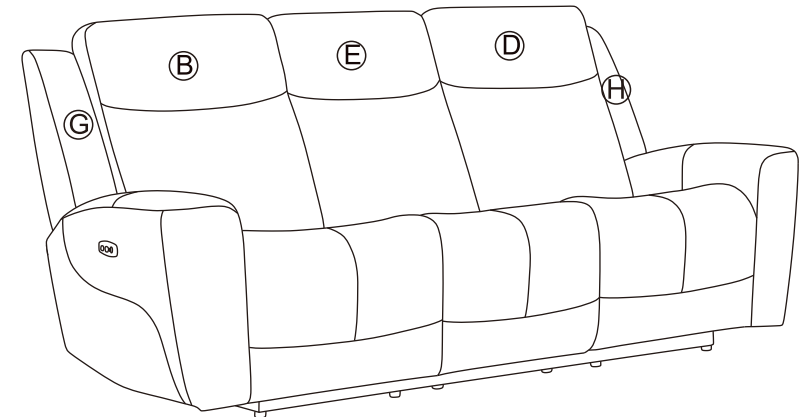
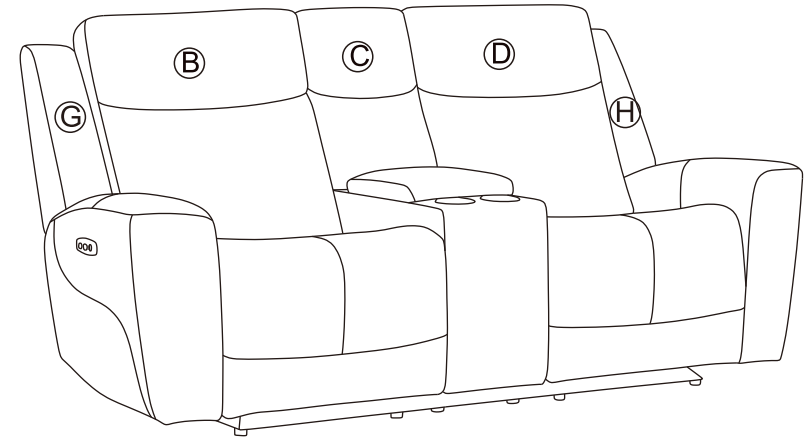
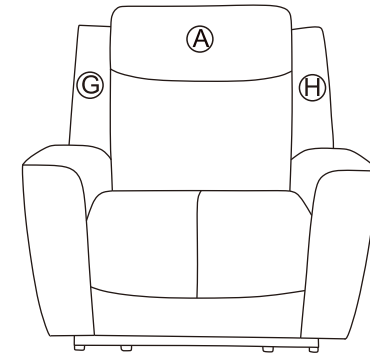

ASSEMBLY INSTRUCTIONS

STEP 1

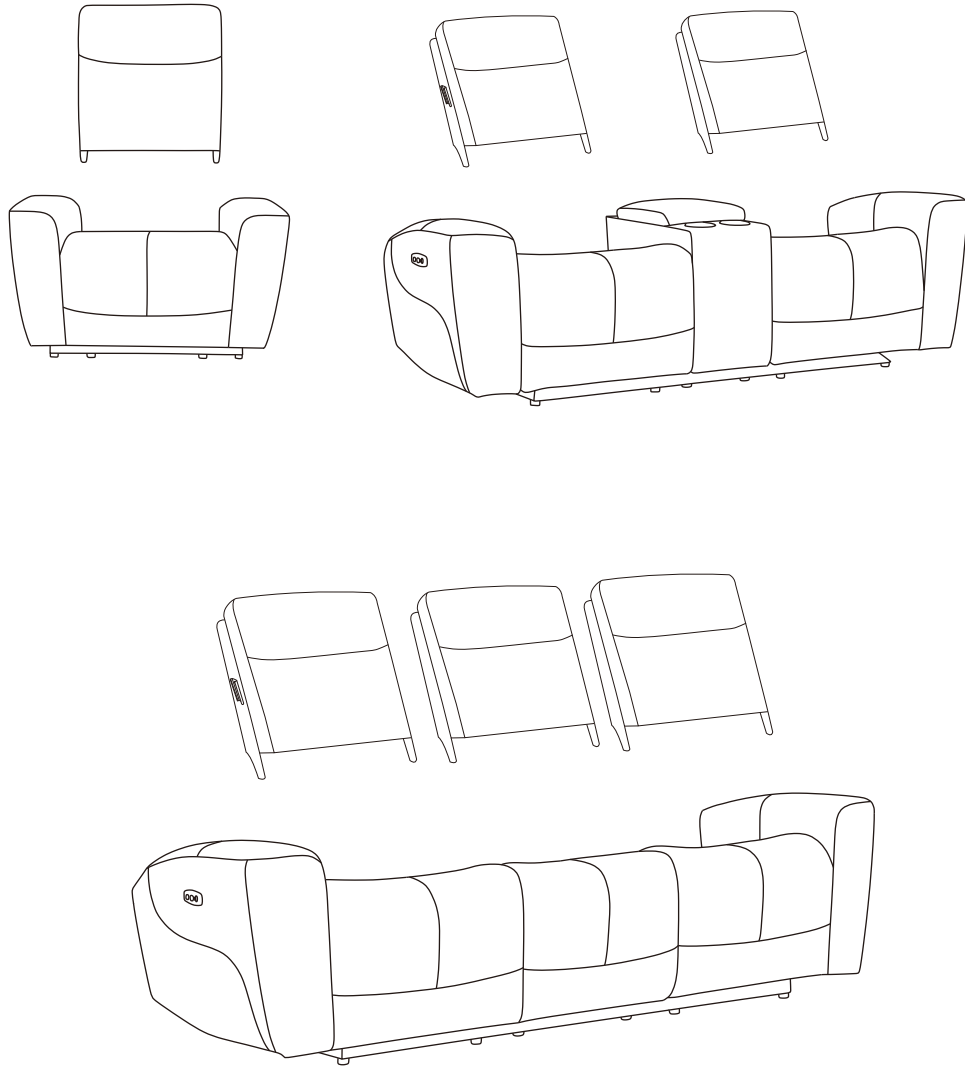

Attaching the Backrest to the Body

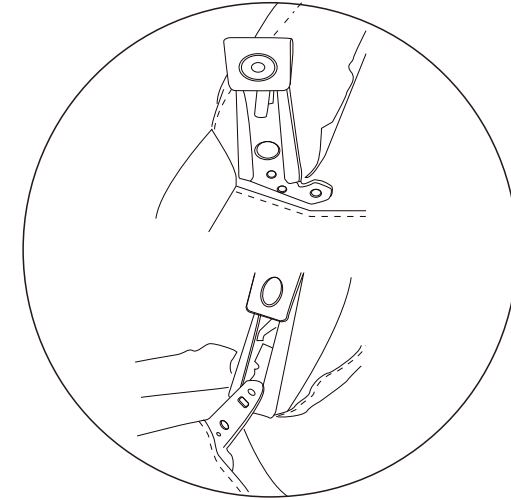

Please align the connectors of the backrest and seat according to the diagram, then press down to ensure a perfect fit.

ASSEMBLY INSTRUCTIONS

STEP 2

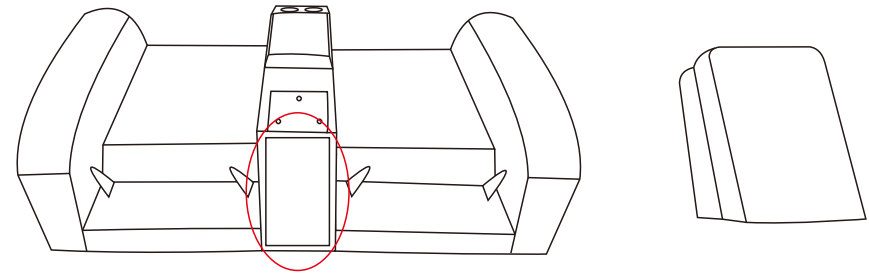
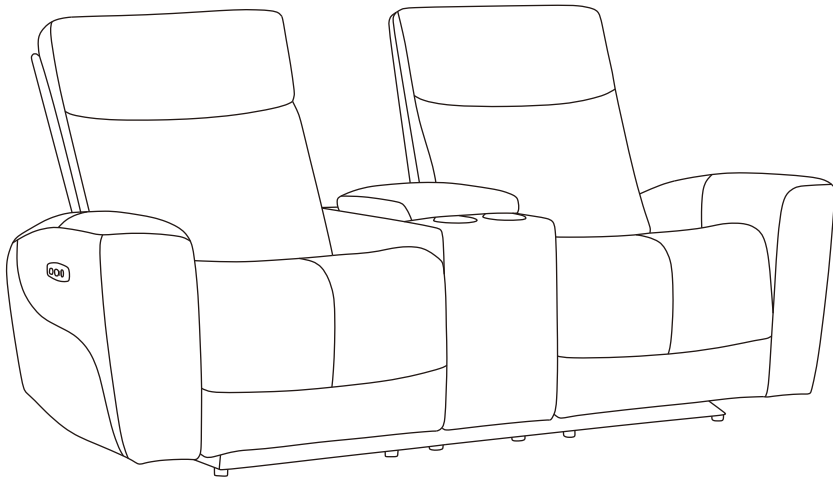

Please Take out the Back(Console) from the bottom of the console
Align the holes of the Back and console, then
tighten the screws in a clockwise direction.

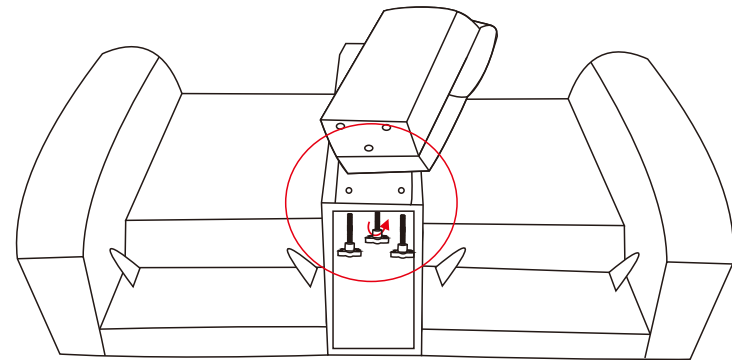

ASSEMBLY INSTRUCTIONS

STEP 3

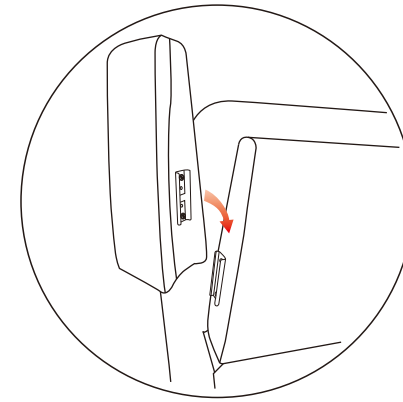
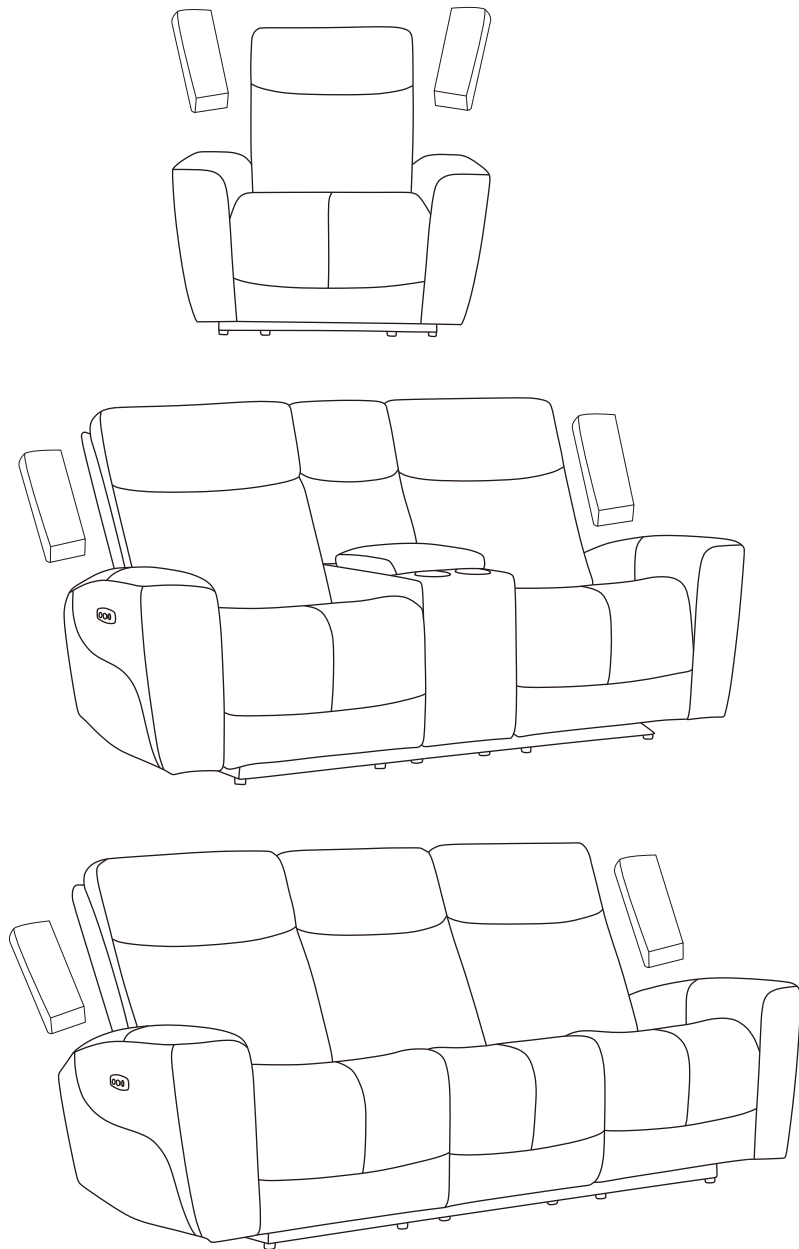

Please connect the backrest and the wing according to the diagram.

ASSEMBLY INSTRUCTIONS

STEP 4/5/6

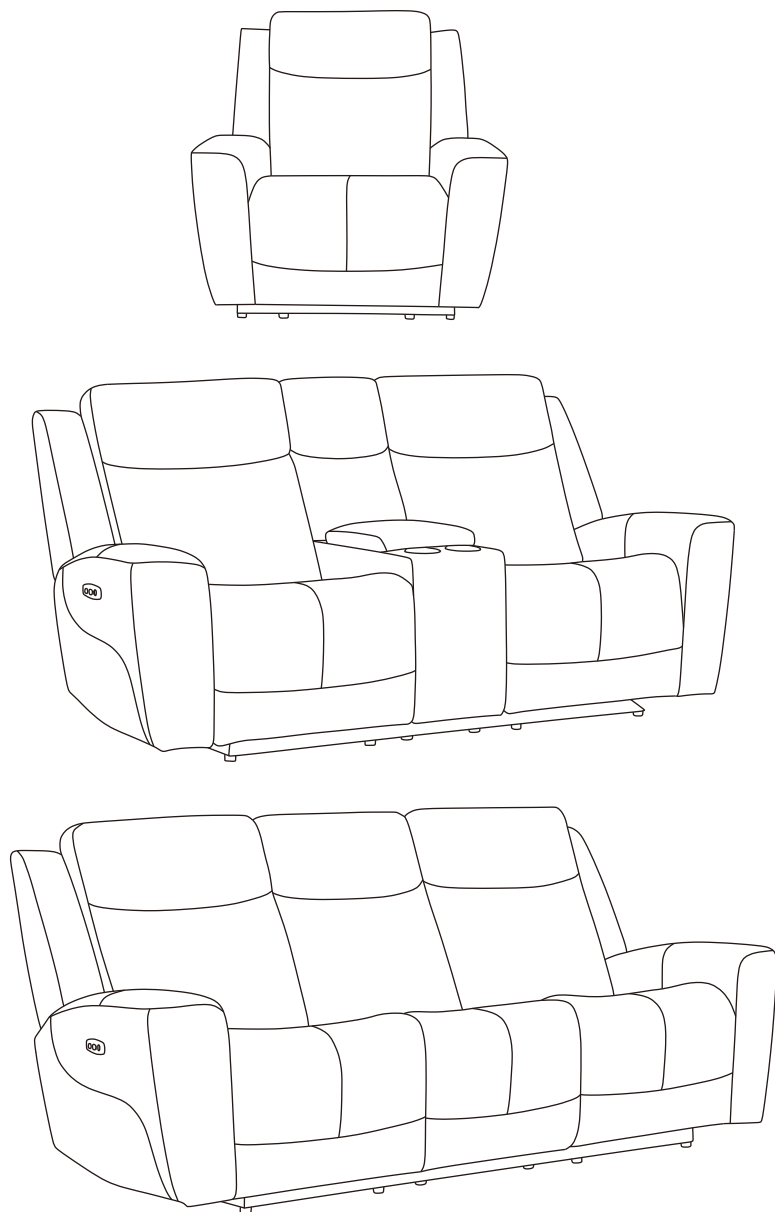

Connect the power port

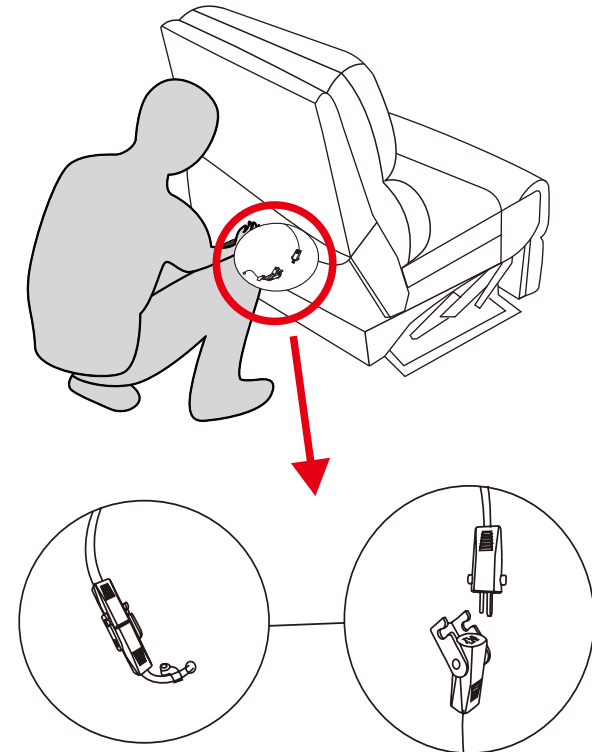

Please check and connect the power port of seat motor and headrest motor, make sure secure the protector.

ASSEMBLY INSTRUCTIONS

Fasten the Velcro

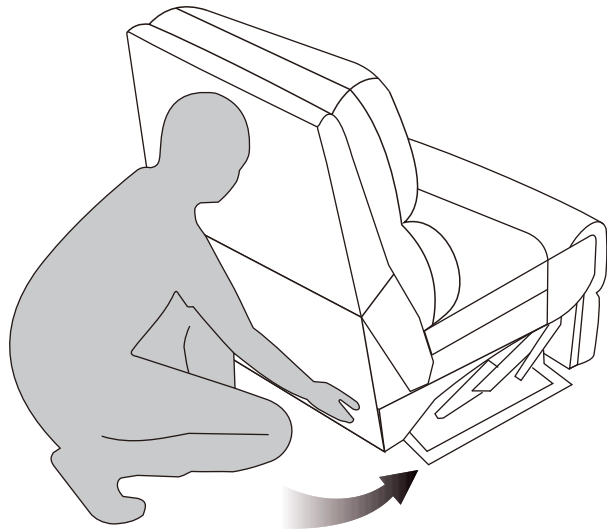

Attach the Velcro on the back of the sofa

Connect the power supply

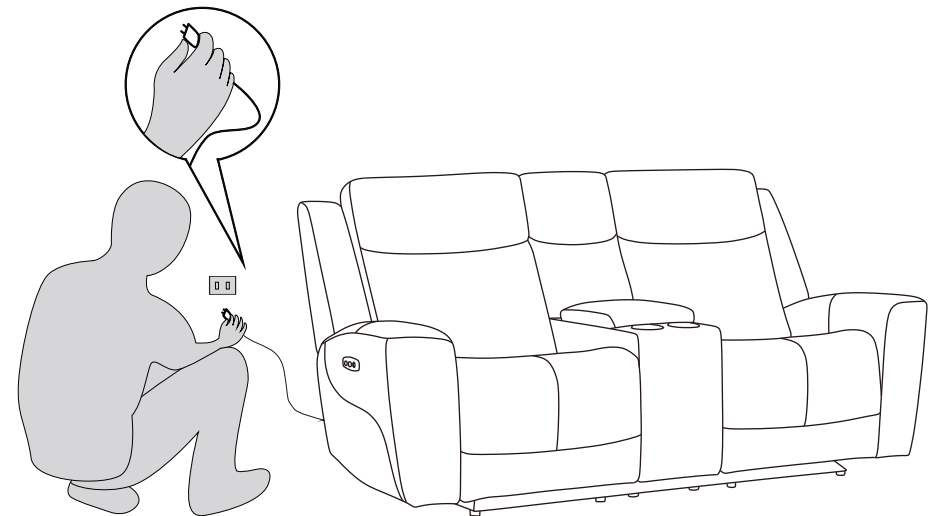

POWER CONNECTIONS

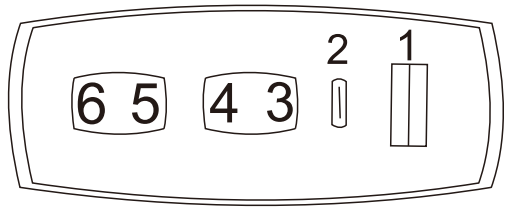
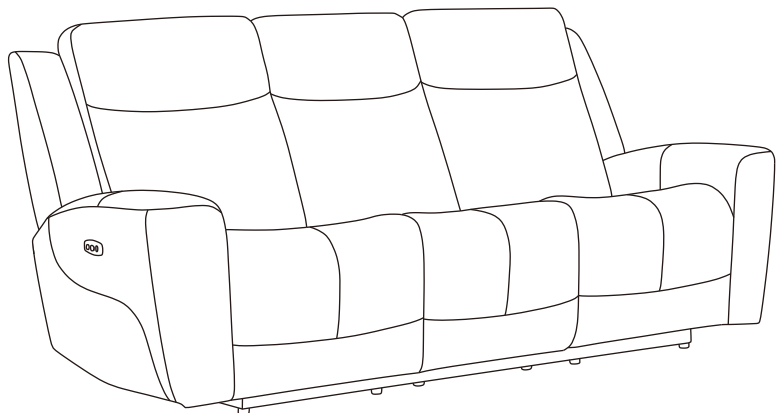
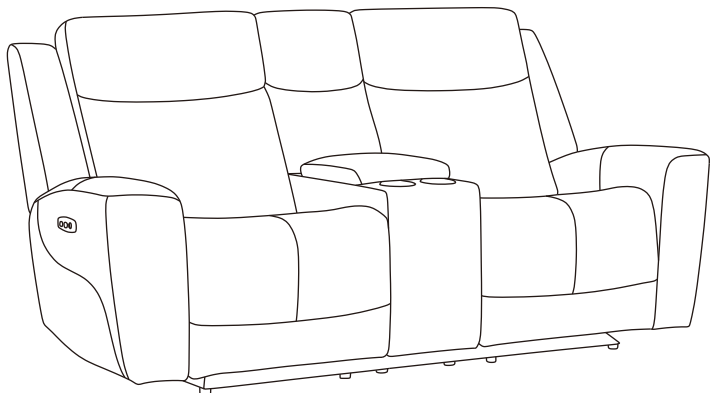
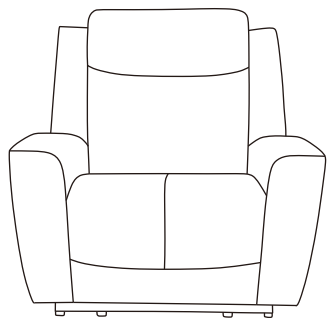

Location	Function
1	USB port
2	Type C
3	Seat Forward
4	Home Button
5	Headrest Forward
6	Headrest Backward