

Assembly Instruction

ITEM NO.: 9637SND-3









SOFA

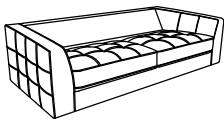

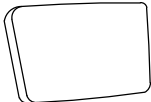
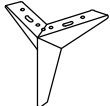
Back Rest are stored at the top of sofa, please take out it for assembly hardware for assembly.

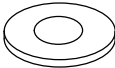
Note: Do not use power tools for assembly. Power tools increase the risk of over tightening which lead to splitting or cracking the wood.

Component list

| No | Drawing | Qty | Description |
|----------|---|----------|--|
| A |  | 1 | SEAT |
| B |  | 1 | LSF BACK REST |
| C |  | 1 | RSF BACK REST |
| D |  | 4 | SILVER METAL LEG |
| E |  | 8 | BOLT (5/16" x 25mm) |
| F |  | 8 | SPRING WASHER (5/16") |
| G |  | 8 | FLAT WASHER (5/16"*19*1.5mm) |
| H |  | 1 | ALLEN KEY (M4*59mm) |
| I |  | 1 | MIDDLE LEG (φ60x130) |
| J |  | 1 | PLASTIC GAKET (φ10φ45T2) |

Step #1

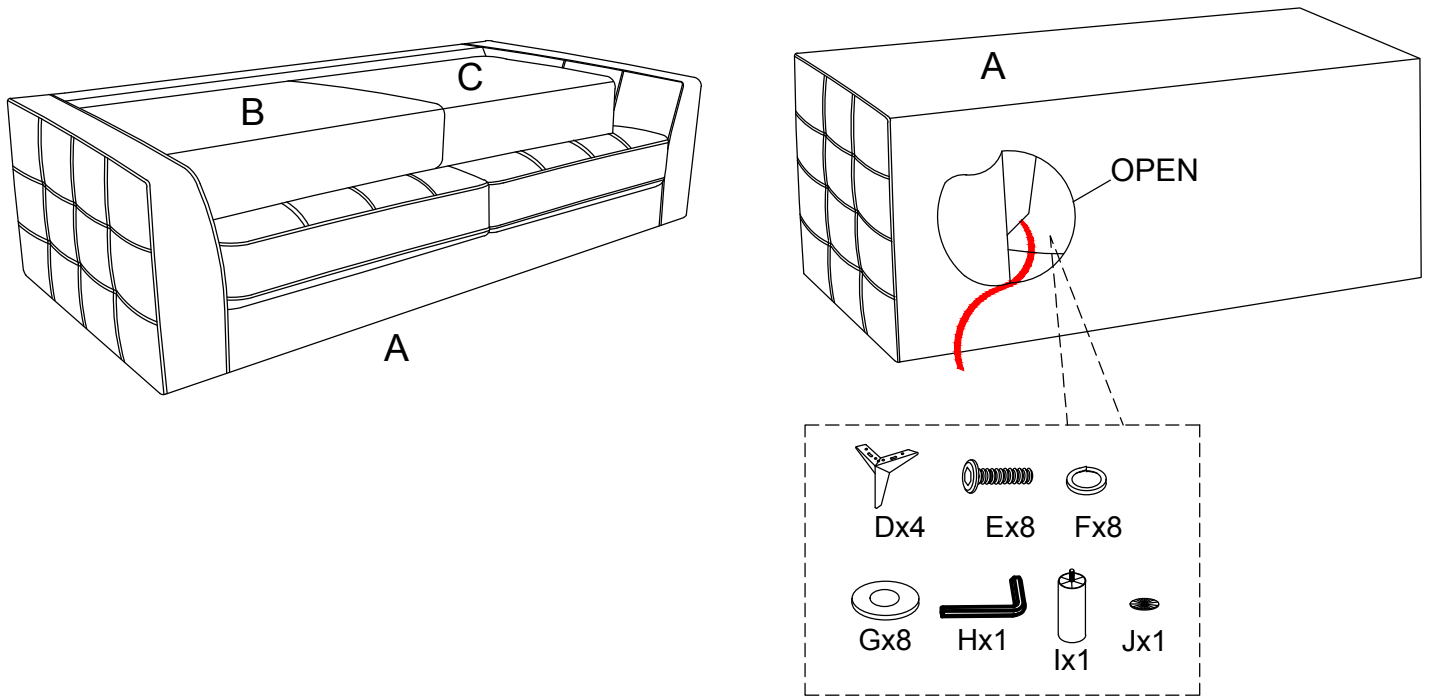

Step #2

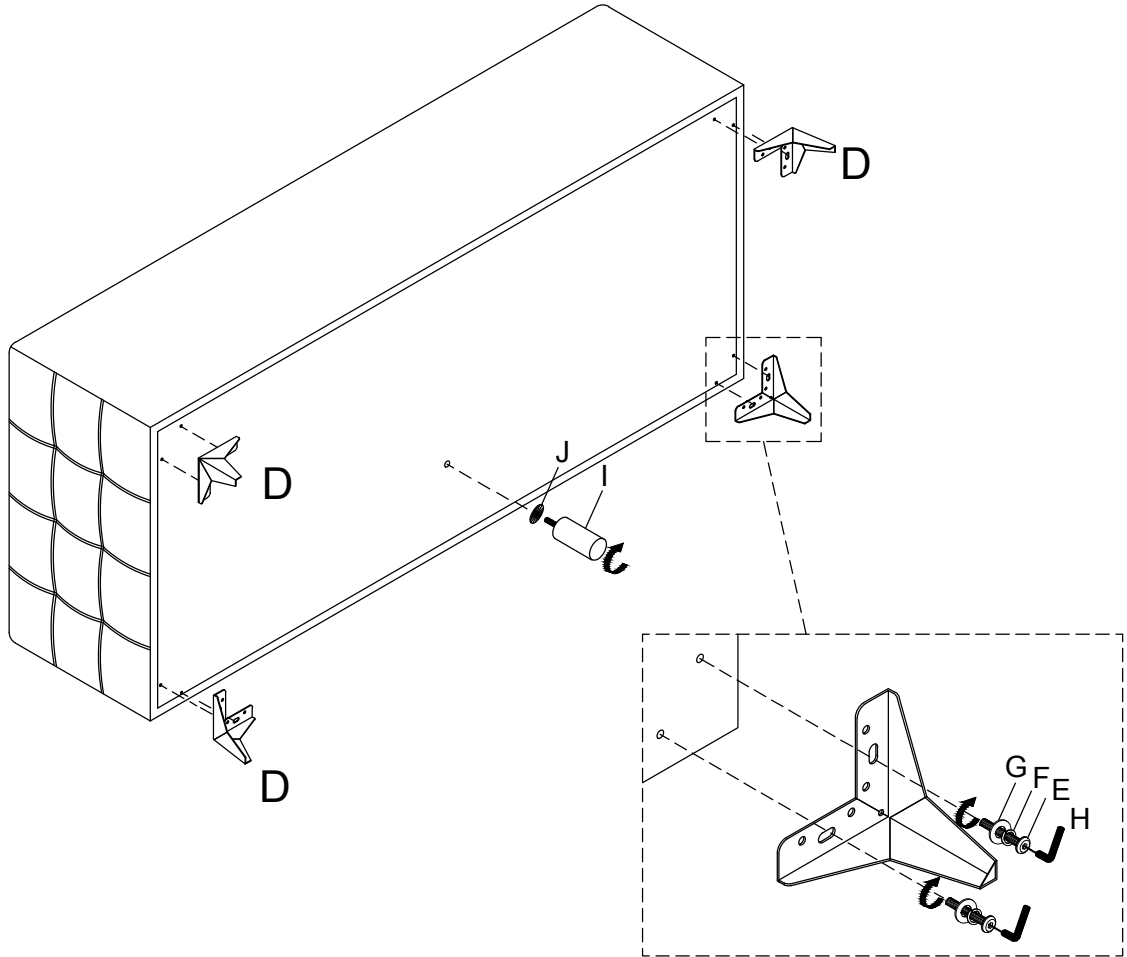

Step #3

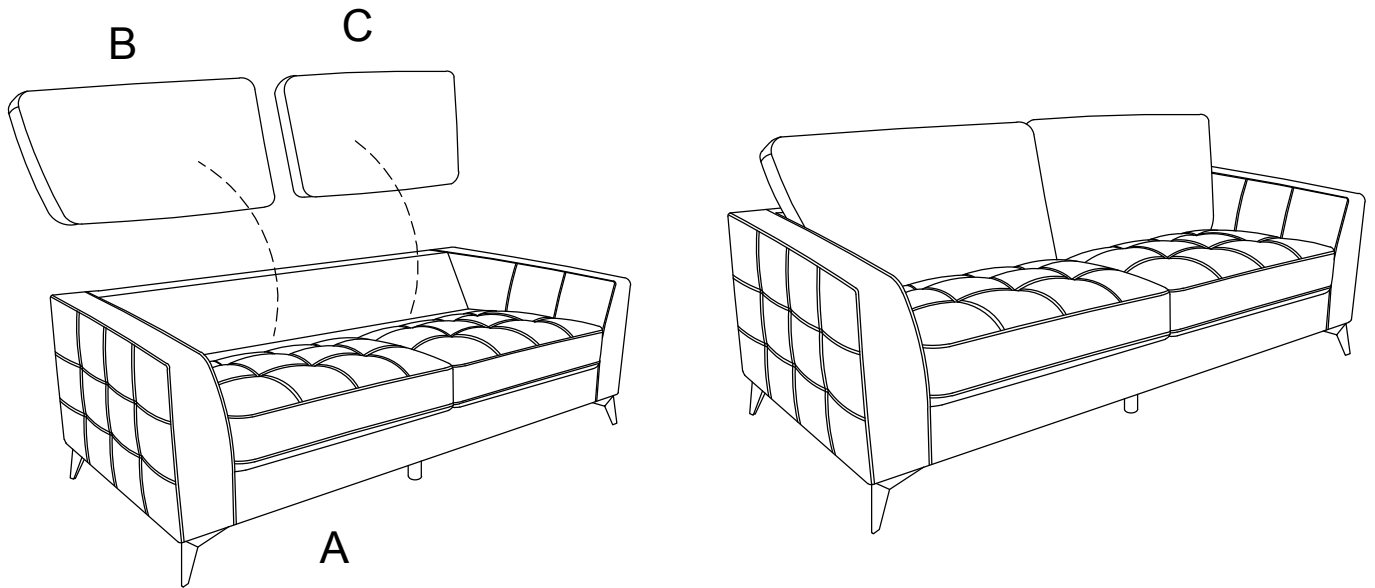

Care Instruction for Polished Microfiber Furniture:

In order to maintain the original appearance of your Polished Microfiber Furniture,

please follow below simple care procedures:

- Avoid exposing furniture directly to sunlight or heating and air conditioning outlets. Sunlight and or exposure to heating and air conditioning outlets will fade/damage Polished Microfiber.
- Vacuum or wipe with a soft cloth to remove dust.
- Hardware may loosen over time. Periodically check to make sure all connection are tight, Re-tighten if necessary.



For items use on wooden floor, hard surfaces or carpets, it is recommended to Install protective pads under all legs and supports to avoid/prevent from damages/scratches and discoloration.