

Assembly Instruction

ITEM NO.: 9555BEG/9555BRW-CR







(2/3)Corner Seat

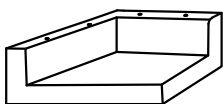

Legs & hardware are stored in the box, please take out the legs and hardware for assembly.

Note: Do not use power tools for assembly. Power tools increase the risk of over tightening which lead to splitting or cracking the wood.

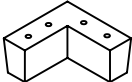
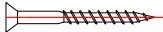
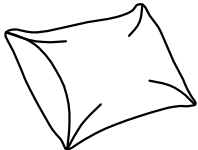
Chair Component list

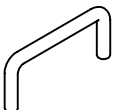
No	Drawing	Qty	Description
A		1	SEAT
B		1	SEAT CUSHION
C		2	HEADREST
D-R		1	LSF BACK CUSHION
D-L		1	RSF BACK CUSHION
E		4	PLASTIC LEG 150*150*70mm
F		16	SCREW M4*70mm
G		1	SQUARE PILLOW 550*550*120mm
H		1	SQUARE PILLOW 480*480*120mm
I		2	CONNECTION LOCK 78*50*40mm

THE PARTS ARE LOCATED INSIDE THE BOX AS BELOW:

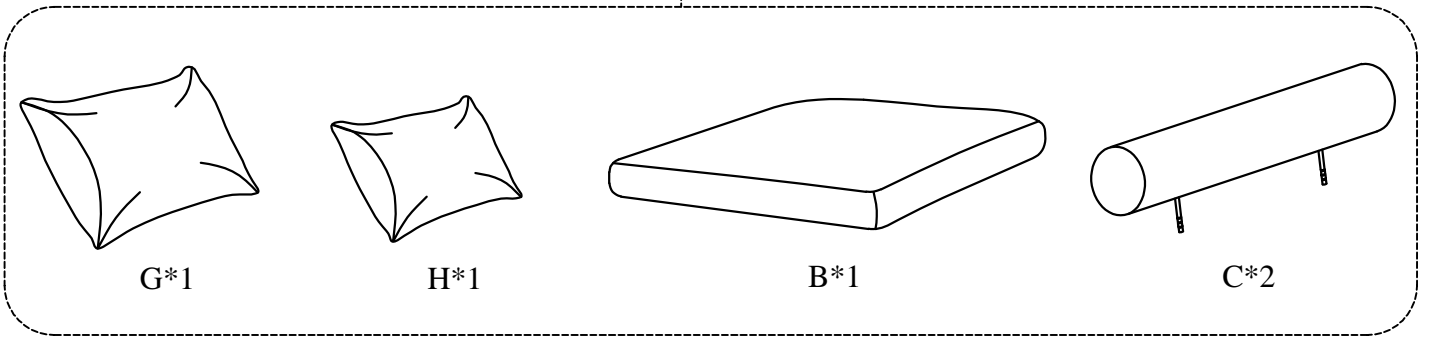
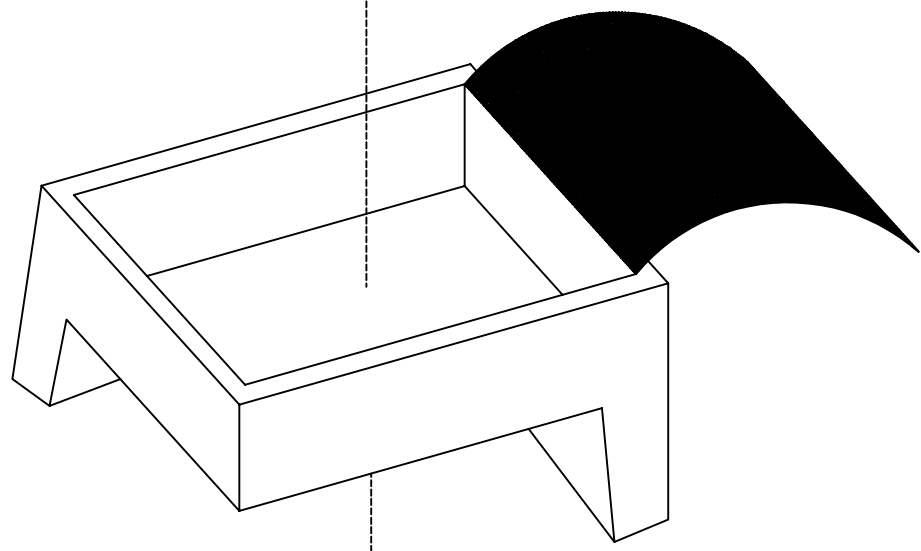
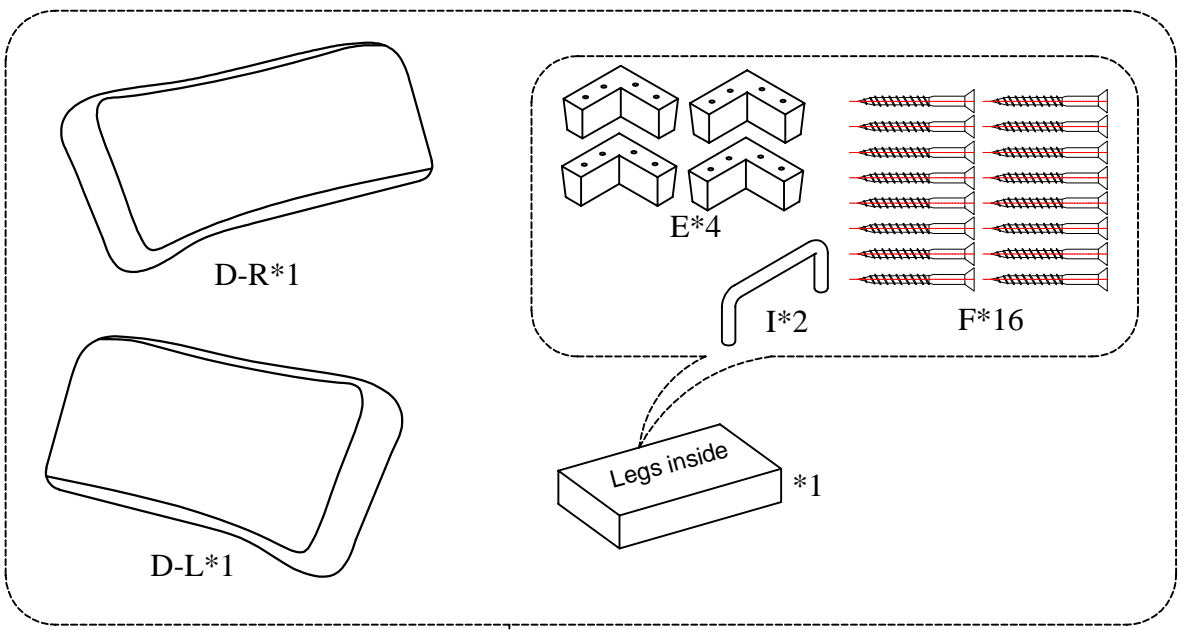

Step #1

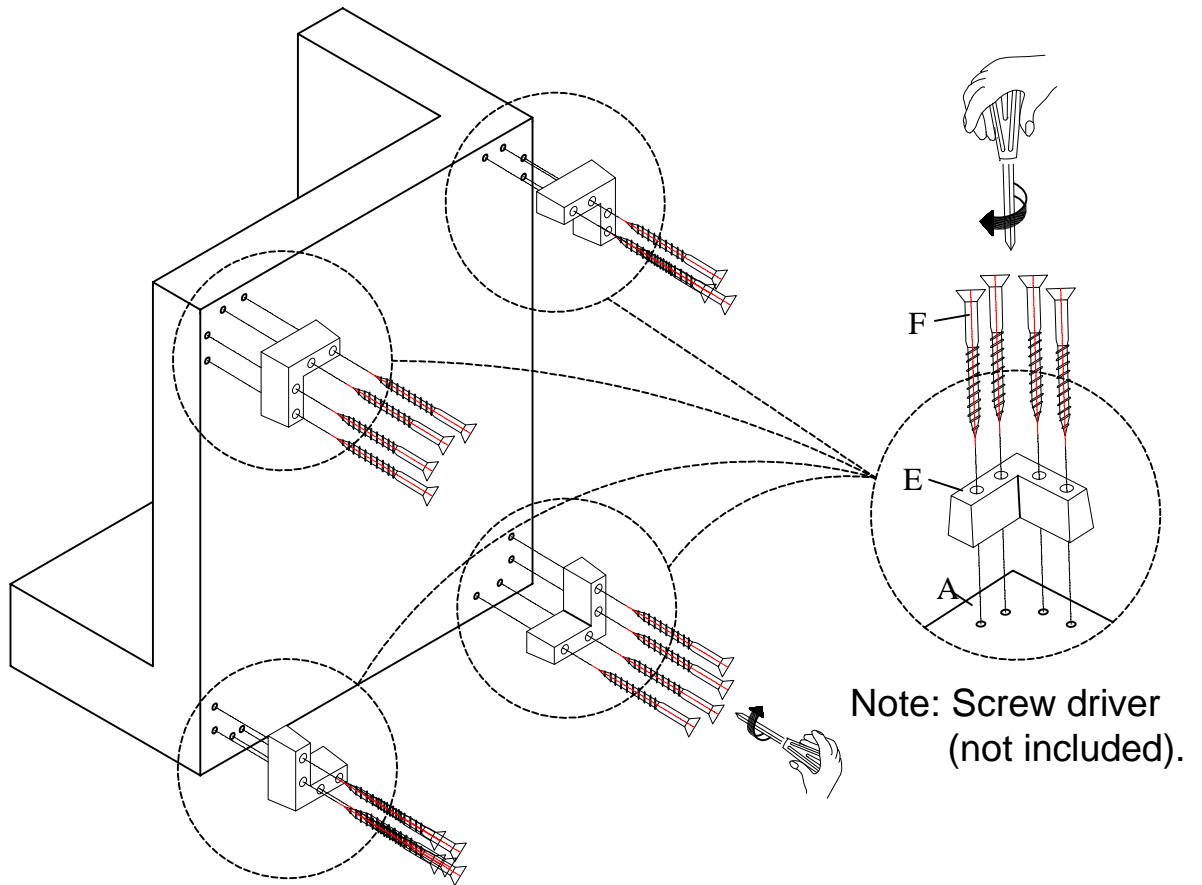

Step #2

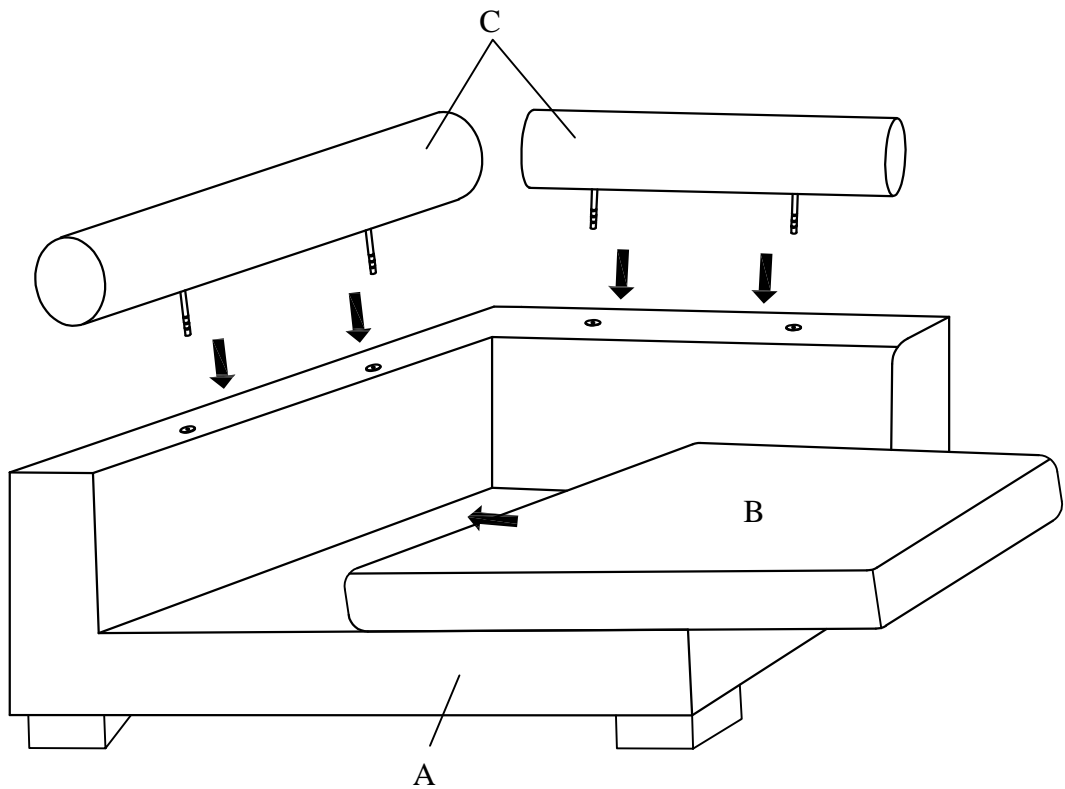

Step #3

Note: Adjust head pillow height as desired.

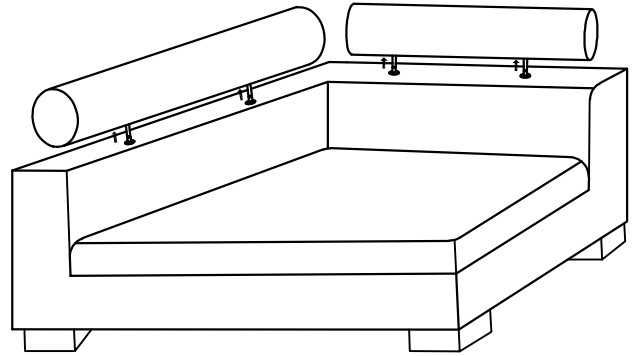
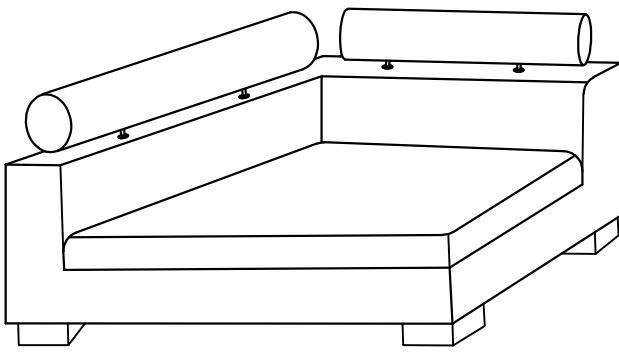

Step #4

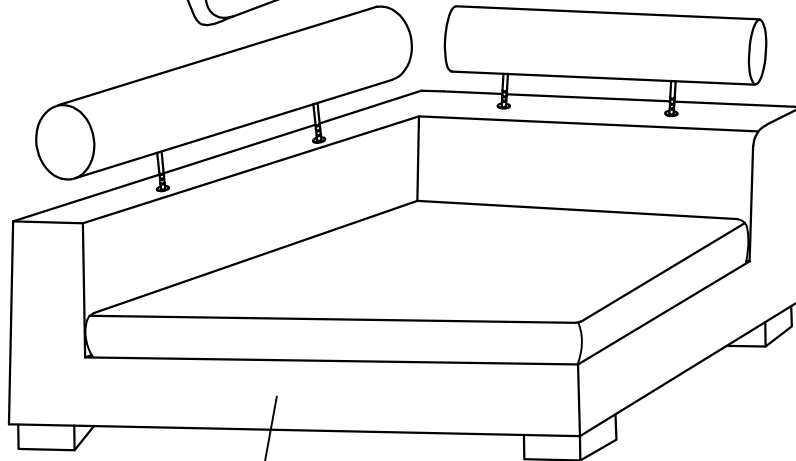
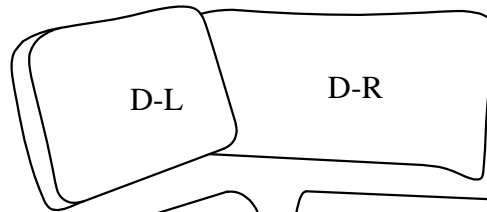
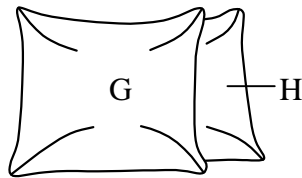

A

Step #5

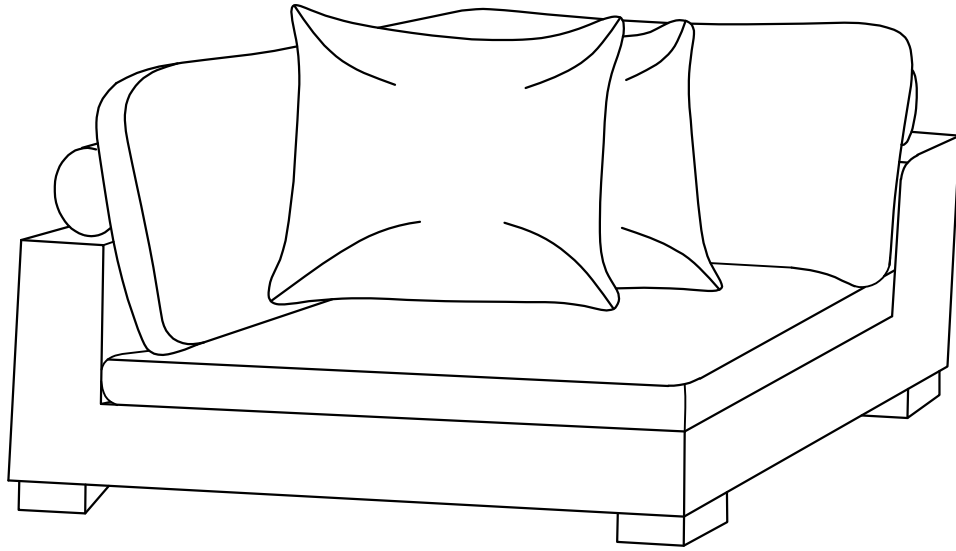

Step #6

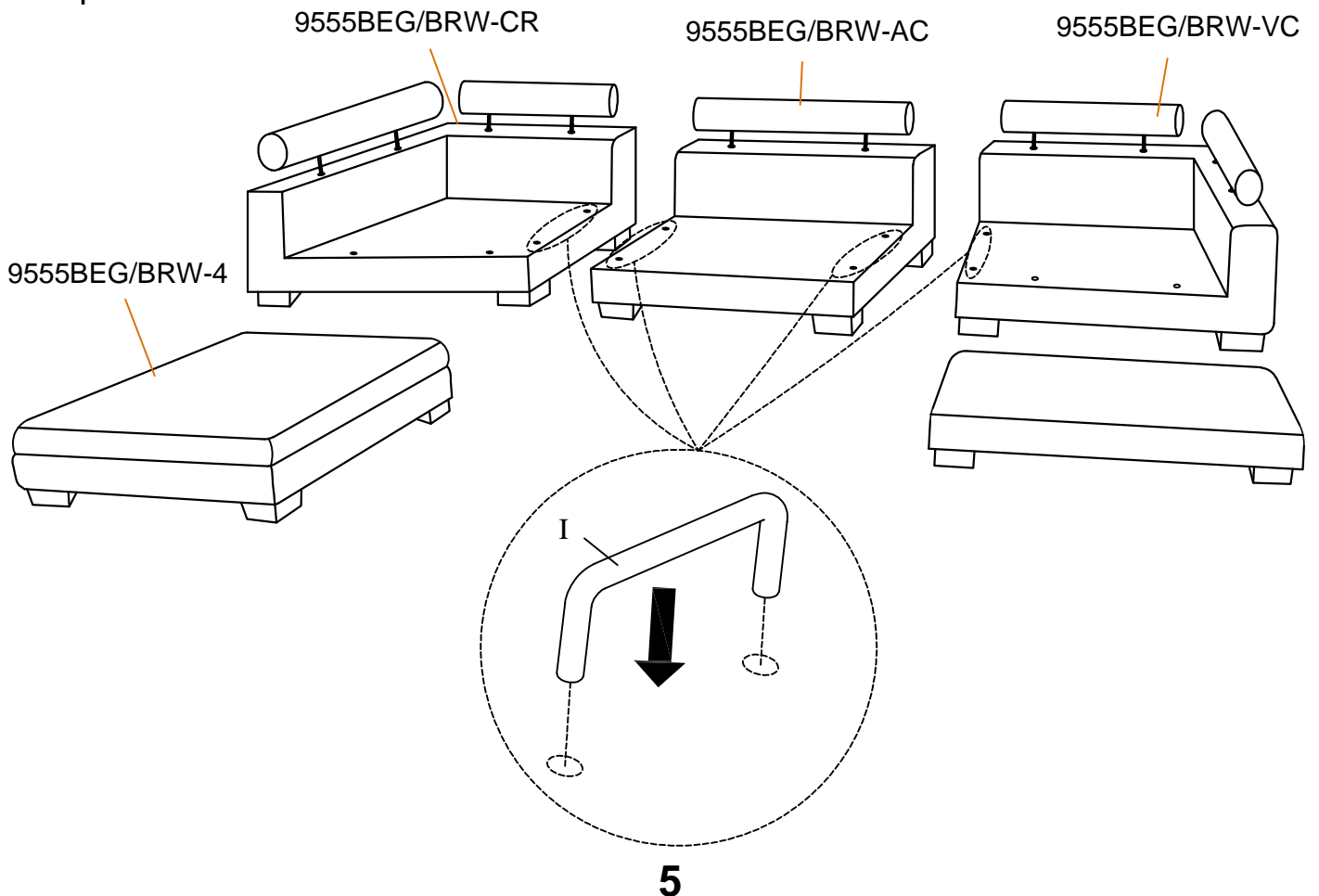

Step #7

Assembly completed.

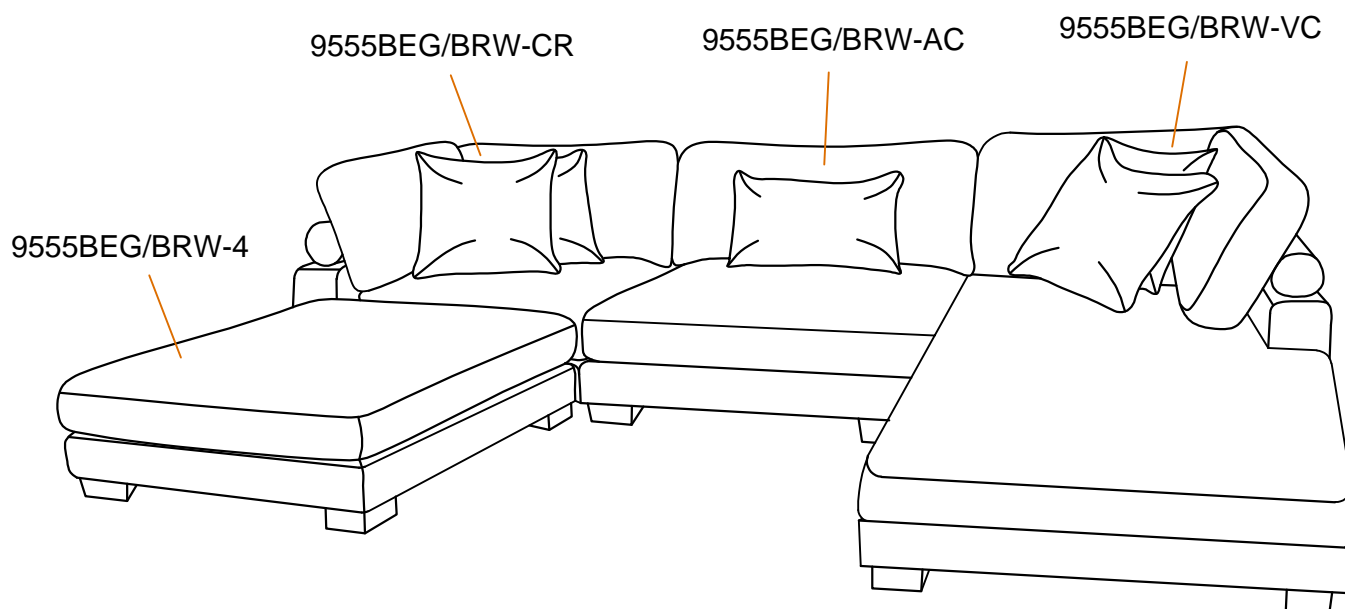

Care Instruction for Textured Microfiber Furniture:

In order to maintain the original appearance of your textured microfiber please follow below simple care procedures:

- Avoid exposing furniture directly to sunlight or heating and air conditioning outlets. Sunlight and/or exposure to heating and air conditioning outlets will fade/damage textured microfiber. Do not place your upholstered furniture too close to windows, radiators, or vents, and be sure to use windows, radiators, or vents.
- Vacuum or wipe with a soft cloth to remove dust.
- Hardware may loosen over time. Periodically check to make sure all connections are tight. Re-tighten if necessary.



For items use on wooden floor, hard surfaces or carpets, it is recommended to Install protective pads under all legs and supports to avoid/prevent from damages/scratches and discoloration.