

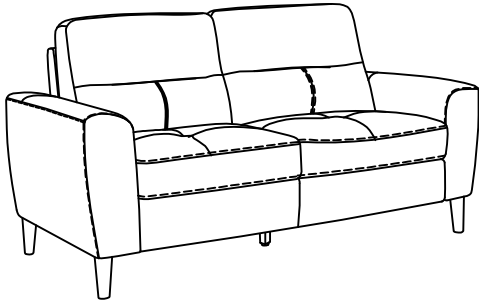

ASSEMBLY INSTRUCTION INSTRUCTIONS D'ASSEMBLAGE

ITEM NO : 8566BLK / LTE-2 Love seat/ Latte

Thank you for purchasing the product. Please take time to read and follow the instruction below. Check that you have all parts and hardware before assembly. Parts apparently missing are often found in the packing materials. If you do not have all the parts listed, have your dealer contact us and they will be sent to you immediately.



Merci d'avoir acheté ce produit. Veuillez lire et suivre les instructions ci-dessous. Vérifiez avant le montage que vous avez toutes les pièces et fixations. Les pièces qui semblent manquer se trouvent souvent dans les matériaux d'emballage. Si vous n'avez pas toutes les pièces de la liste, demandez à votre détaillant et nous vous les enverrons immédiatement.



It is recommended to install protective pads under all legs and supports to avoid damage or scratches when placing furniture on a wood floor or other hard surface, and to limit indentation and prevent discoloration if placing on carpet.



Il est recommandé de placer des coussins protecteurs sous tous les pieds et toutes les bases des meubles pour éviter d'endommager ou d'égratigner les planchers en bois ou autres surfaces dures, et pour limiter l'empreinte et empêcher la décoloration quand les meubles reposent sur la moquette.



Hardware may loosen over time. Periodically check to make sure all connections are tight. Re-tighten if necessary.



Le matériel peut se desserrer au fil du temps. Vérifiez périodiquement que toutes les connexions sont serrées. Serrer à nouveau si nécessaire.

PARTS LIST/ LISTE DE PIÈCES

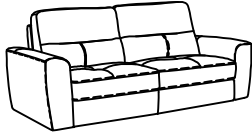
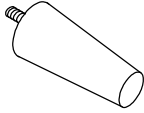
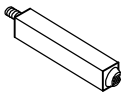
| No | Drawing/ DESSIN | Description | QTY/QTÉ |
|----|---|--|---------|
| A |  | Love seat/ Latte | 1 |
| B |  | Wooden Leg/ pied en Wooden | 4 |
| C |  | Center Support Leg / Support pour transverses central | 1 |

HARDWARE LIST/ LISTE DE QUINCAILLERIE

| No | Description | Sketch/Esquisser | QTY/QTÉ |
|----|--|---|---------|
| 1 | Plastic Washer Ø 47mm (8mm)/ Rondelle en plastique |  | 5 |

**ABOVE HARDWARE ARE PACKED IN 8566BLK/LTE-2 FOR ASSEMBLY/ Le quincaillerie est dans 8566BLK/LTE-2 pour l'assemblage.

(Step 1/Étape 1)
 Love seat/ Latte

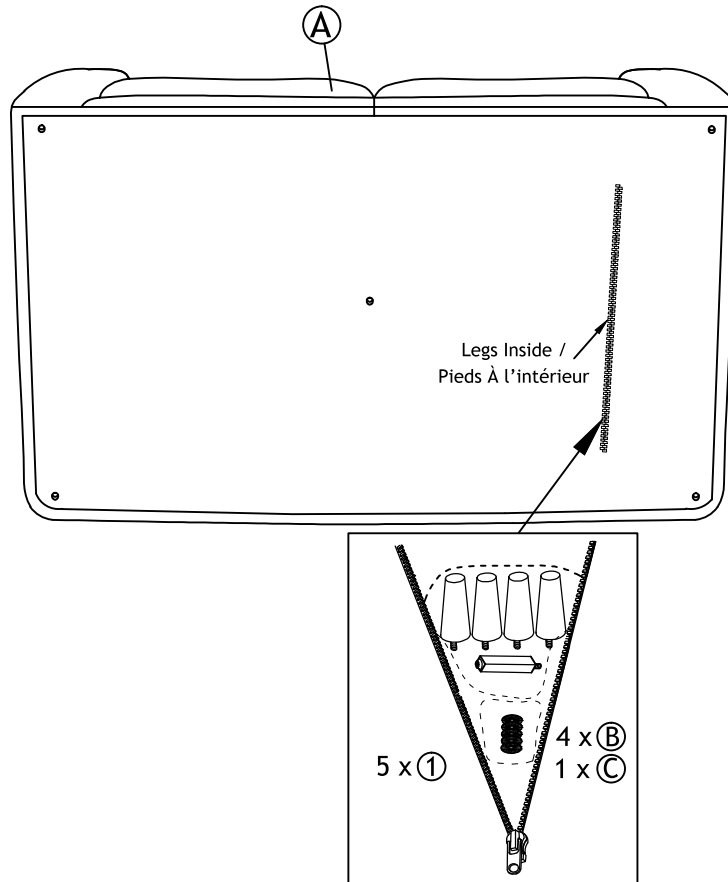

(Step 2/Étape 2)
 Love seat/ Latte

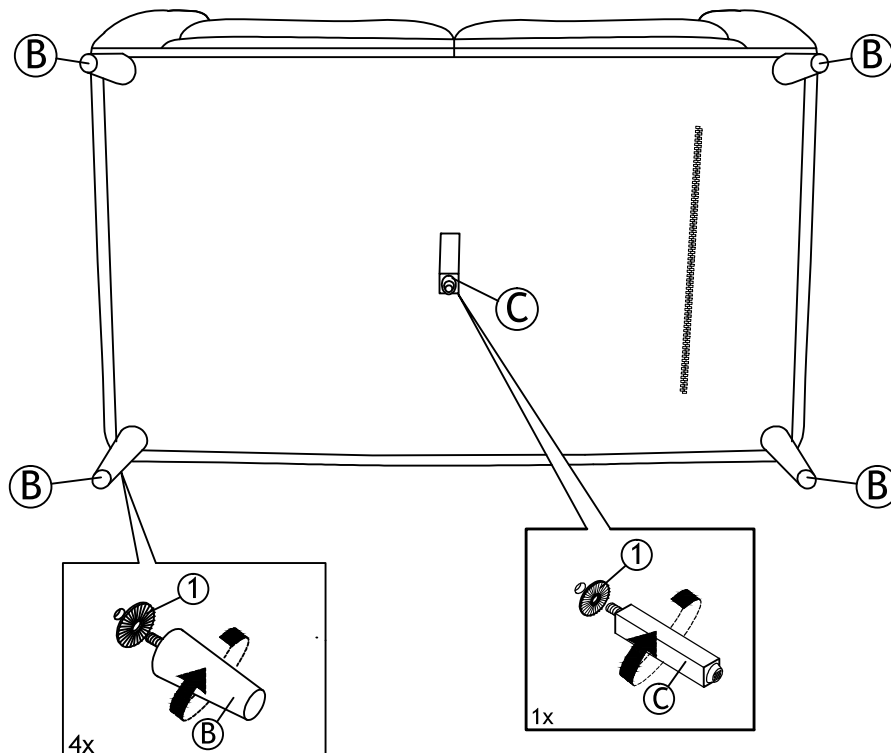



ASSEMBLY INSTRUCTION
INSTRUCTIONS D'ASSEMBLAGE
ITEM NO : 8566BLK / LTE-2 Love seat/ Latte

(Step 3/Étape 3) Assembly Completed/Assemblage Completé

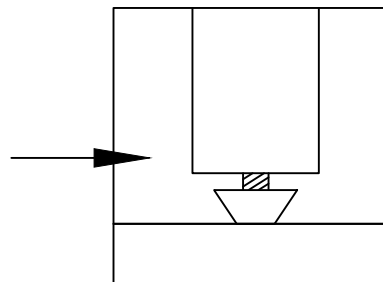
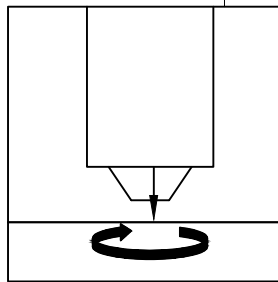
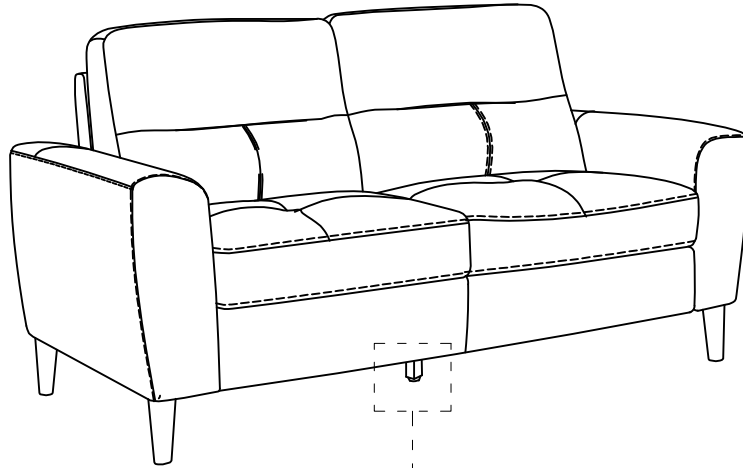

Upholstery Cushion Care / instructions De Soins Pour Meubles Rembourrage

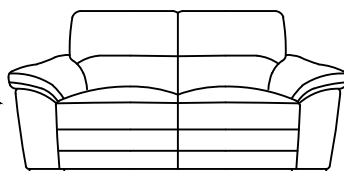
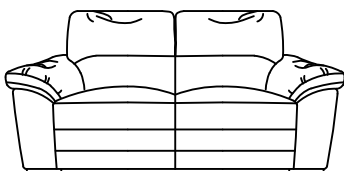
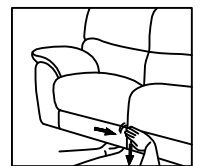
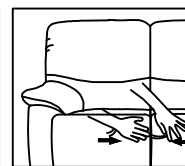
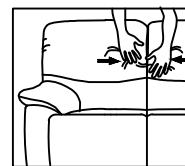
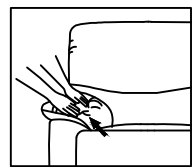
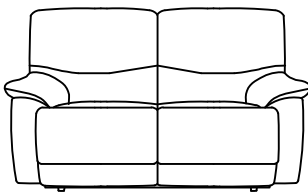
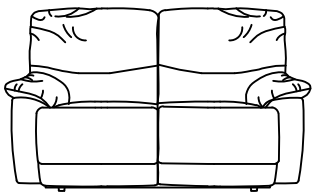

TOP GRAIN LEATHER MATCH PVC CARE INSTRUCTION.
INSTRUCTIONS POUR LES SOINS DU CUIR ET PVC:

- Avoid exposing furniture directly to sunlight or heating and air conditioning outlets.
- Éviter d'exposer les meubles aux rayons directs du soleil ou aux sorties de chaleur et d'air climatisé.
- Exposure to sunlight or heating and air conditioning outlets will fade/damage top grain leather match PVC.
- Éviter d'exposer les meubles aux rayons directs du soleil ou aux sorties de chaleur et d'air climatisé.
- Wipe gently with a damp soft cloth to remove dust, dirt and any buildup.
- Pour enlever la poussière, essuyer avec un chiffon doux.