

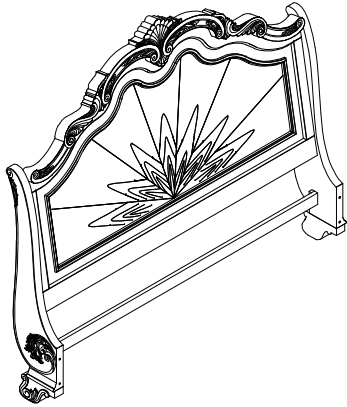





ASSEMBLY INSTRUCTION INSTRUCTION DE MONTAGE



ITEM NO: 2243SL-1 QUEEN SLEIGH BED HEADBOARD/ TÊTE DE LIT
2243SLK-1 KING SLEIGH BED HEADBOARD/ TÊTE DE LIT







Thank you for purchasing this product. Please take time to read and follow the instructions below. Check that you have all parts and hardware before assembly. Parts apparently missing are often found in the packing materials. If you do not have all the parts listed, have your dealer contact us and they will be sent to you immediately.

Merci d'avoir acheté ce produit. Veuillez lire et suivre les instructions ci-dessous. Vérifiez avant le montage que vous avez toutes les pièces et fixations. Les pièces qui semblent manquer se trouvent souvent dans les matériaux d'emballage. Si vous n'avez pas toutes les pièces de la liste, demandez à votre détaillant et nous les enverrons immédiatement.

-  It is recommended to install protective pads under all legs and supports to avoid damage or scratches when placing furniture on a wood floor or other hard surface, and to limit indentation and prevent discoloration if placing on carpet.
-  Il est recommandé de placer des coussins protecteurs sous tous les pieds et toutes les bases des meubles pour éviter d'endommager ou d'égratigner les planchers en bois ou autres surfaces dures, et pour limiter l'empreinte et empêcher la décoloration quand les meubles reposent sur la moquette.
-  Hardware may loosen over time. Periodically check to make sure all connections are tight. Re-tighten if necessary.
-  Le matériel peut se desserrer au fil du temps. Vérifiez périodiquement que toutes les connexions sont serrées. Serrer à nouveau si nécessaire.

2243SL-1/ 2243SLK-1 PART LIST/ LISTE DE PIÈCES			
No	Sketch	Description	Quantity
A		Headboard Panel/ Tête De Lit	1 PC
B		Headboard Post (L/R)/ Poteau De Tête De Lit (Gauche/ Droite)	2 PCS
C		Cross Bar/ Barre Transversale	1 PC

HARDWARE LIST/ LISTE DE QUINCAILLERIE				
No	Description	Size	Sketch	Quantity
1	Bolt/ Boulon	Ø1/4" x 1-3/4"		10 PCS
2	Lock Washer/ Rondelle D'arrêt	Ø1/4"x1/2"		10 PCS
3	Flat Washer/ Rondelle Plate	Ø1/4"x3/4"		10 PCS
4	Allen Key/ Clé Allen	2-1/4" x 5/32"		1 PC

* ABOVE HARDWARE ARE PACKED IN 2243SL-1/ 2243SLK-1 FOR ASSEMBLY.

STEP 2/ ÉTAPE 2

STEP 1/ ÉTAPE 1

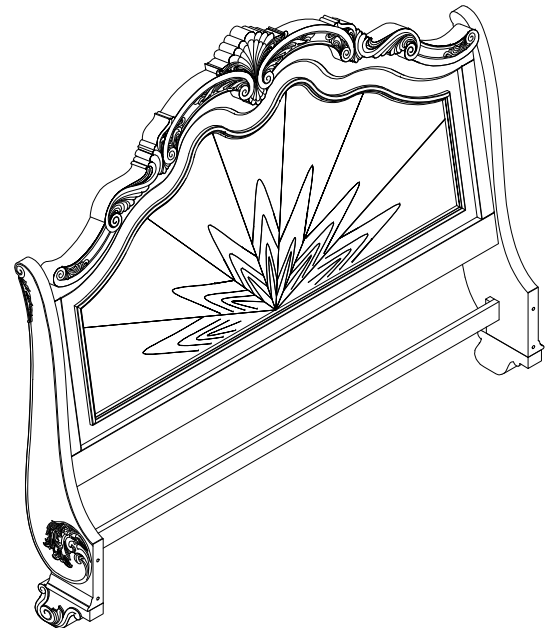
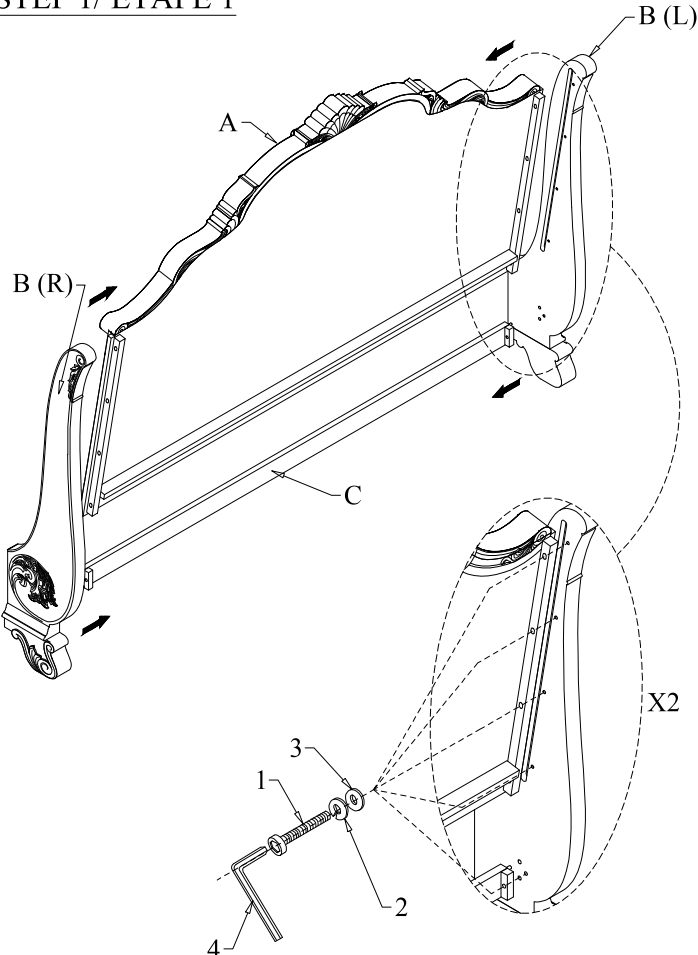

COMPLETED/
COMPLÉTÉ

PAGE 1 OF 1/ PAGE 1 SUR 1

REVISION 24 SEP 2024