

**ASSEMBLY INSTRUCTION**  
**SH202TBGE-1 & SH202TBLU-1 & SH202TGRY-1 &**  
**SH202TDGR-1 & SH202TPNK-1**

**1** Headboard

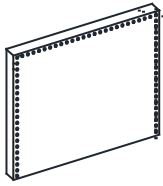

x1

**2** Headboard Leg

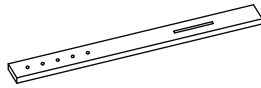

x2

**A** Bolts  
M8 x 50mm

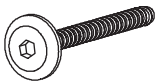

x4

**B** Lock Washer  
(for M8)



x4

**C** Flat Washer  
(for M8)



x4

**D** Bolts  
M6 x 50mm

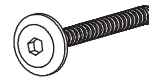

x4

**E** Lock Washer  
(for M6)



x4

**F** Flat Washer  
(for M6)



x8

**G** Hex Nut



x4

**H** Allen Key  
M4 x 65mm



x1

**I** Allen Key  
M5 x 65mm



x1

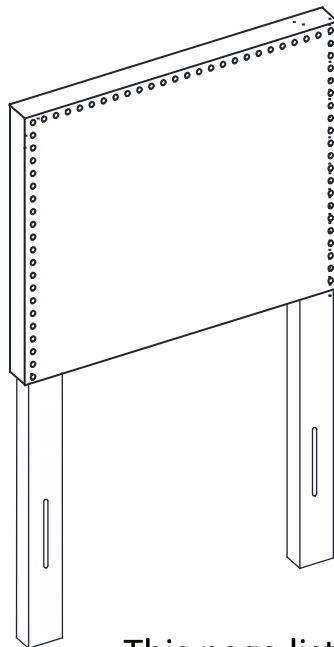

This page lists all the contents included in the box. Please take the time to identify the hardware as well as the individual components to this product. As you unpack and prepare for assembly, place the contents on a carpeted or padded area to protect them from damage.

# ASSEMBLY INSTRUCTION

## SH202TBGE-1 & SH202TBLU-1 & SH202TGRY-1 & SH202TDGR-1 & SH202TPNK-1

- 1** Begin assembly by attaching each Headboard Leg (2) to the bottom of the Headboard (1) by aligning the hole and securing with 2 Allen Bolts (A) , 2 Lock Washer (B) , 3 Flat Washer (C) per leg using Allen Key (I) .  
(DO NOT FULLY TIGHTEN BOLTS FOR THIS STEP)

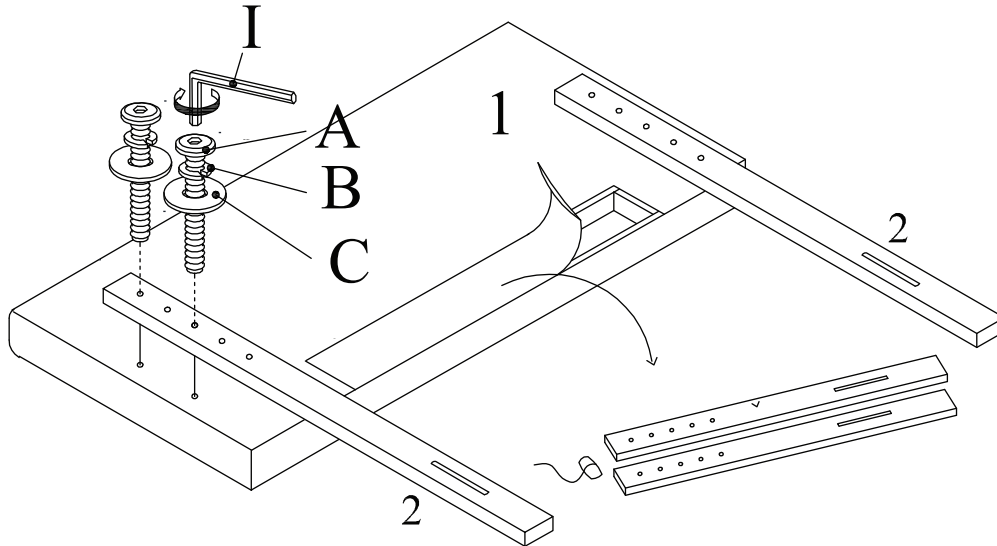

- 2** Attached Bed Rails (not included) to left and right Headboard Legs (2) using 2 Allen bolts (D) and 2 Flat Washer (F) from the back and 2 Flat Washer (F), 2 Lock Washer (E) and 2 Hex Nuts (G) from the front. Tighten all bolts with Allen Key (H) provided.

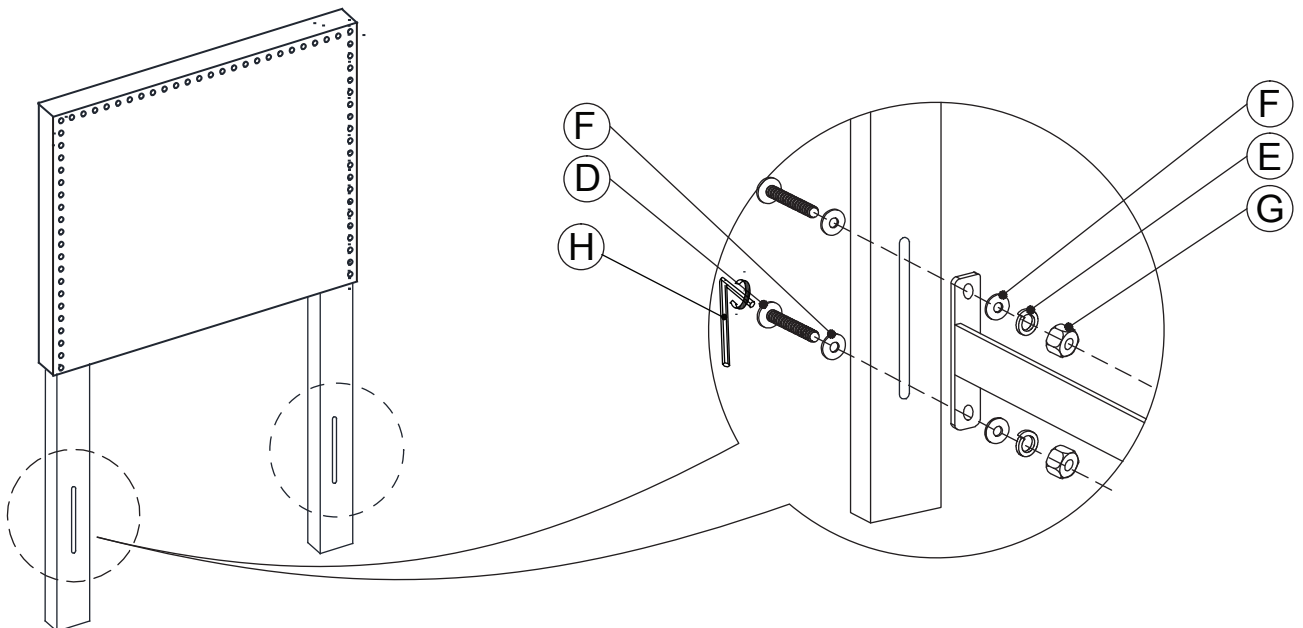

### Cleaning & Care

Treat surface with care. Surface is resistant to scratches but is not scratch resistant. Clean surfaces with a dry or damp soft cloth. Do not use abrasive cleaners. Hardware may loosen over time. Periodically check that all connections are tight.