

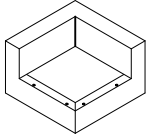

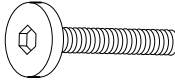



ASSEMBLING INSTRUCTIONS

ITEM NO: 8310NBE-C1A
REVERSIBLE CHAIR WITH ONE ARM

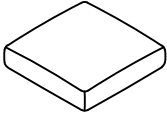
! The legs and Hardware are stored in the bottom of the seat, please take out for assembly.
 Note: Do not use power tools for assembly. Power tools increase the risk of over tightening which lead to splitting or cracking the wood.

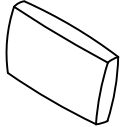
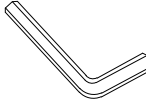
COMPONENT LIST				HARDWARE LIST			
PART	DRAWING	DESCRIPTION	QTY	PART	DRAWING	DESCRIPTION	QTY
A		Seat	1 PC	1		Bolt Ø5/16"x2 -1/2"	4 PCS
B		Plastic Leg 4-1/8"x4-1/8"x2-1/3"	4 PCS	2		Spring Washer Ø5/16"	4 PCS
C		Seat Cushion	1 PC	3		Flat Washer Ø5/16"x3/4"	4 PCS
D		Back Cushion	1 PC	4		Allen KeyM4 2-1/3"	1 PC
E		Pillow 20"x20"	1 PC	5		U Shape Metal Connector Ø3/16" x 8-2/3" x 3-5/32"	2 PCS

ASSEMBLING INSTRUCTIONS

ITEM NO: 8310NBE-C1A
 REVERSIBLE CHAIR WITH ONE ARM

STEP 1:

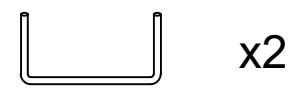
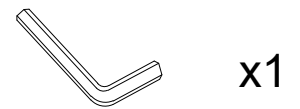
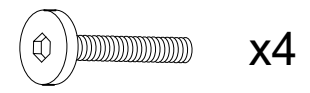
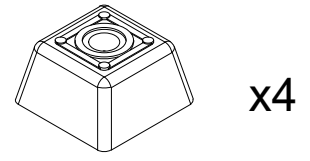
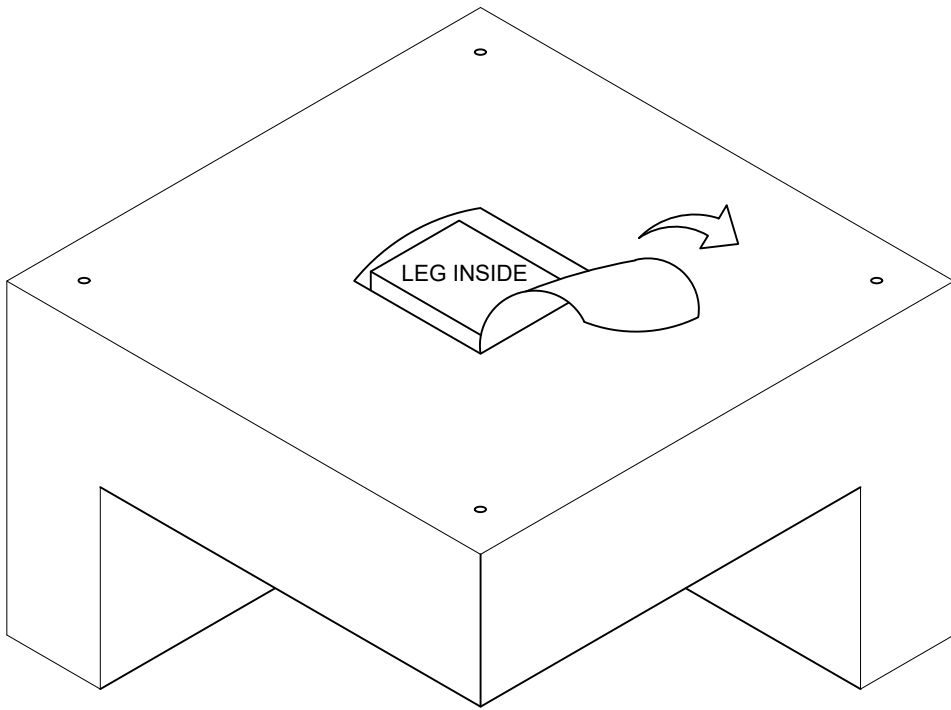

STEP 2:

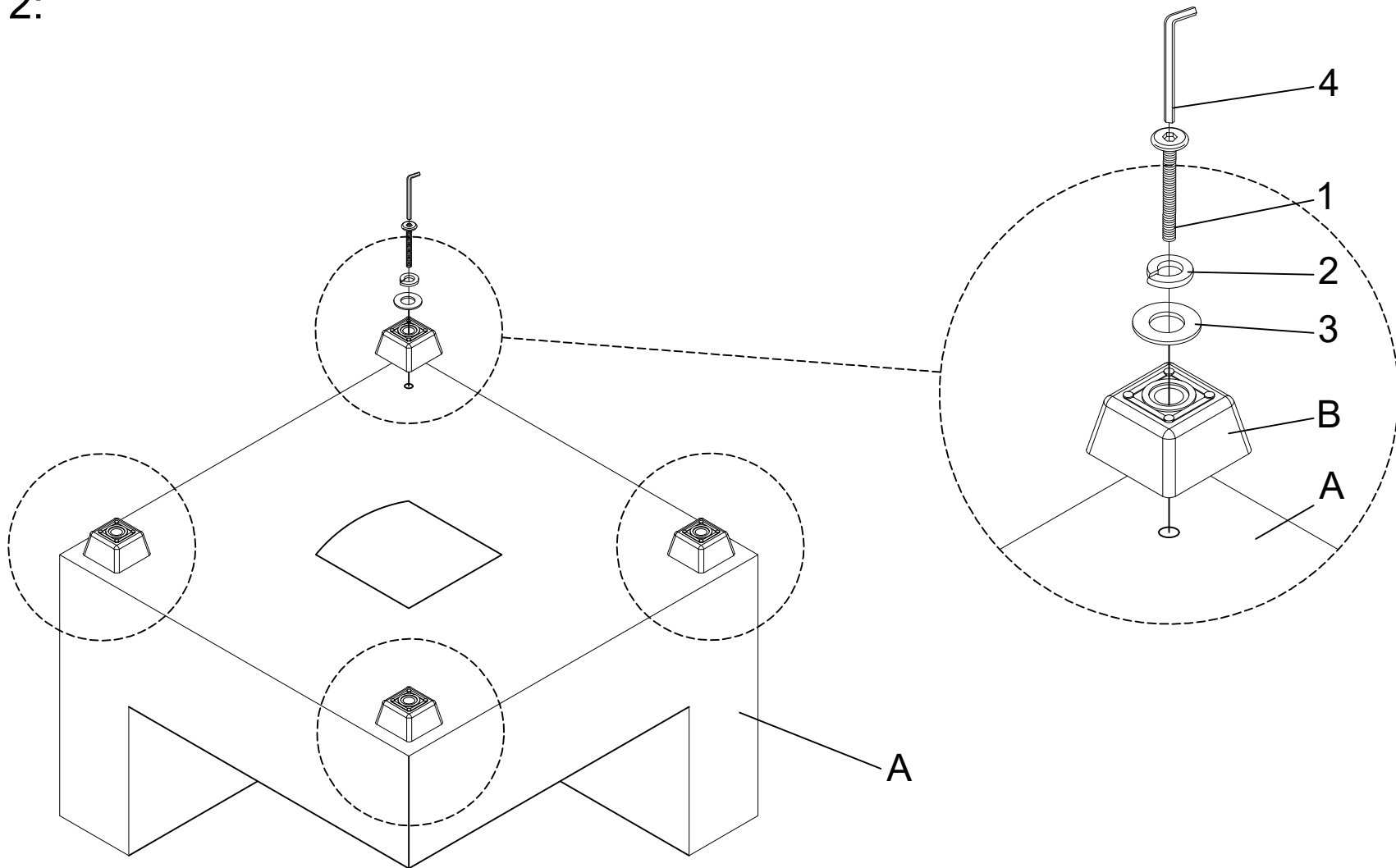

ASSEMBLING INSTRUCTIONS

ITEM NO: 8310NBE-C1A
REVERSIBLE CHAIR WITH ONE ARM

STEP 3A:

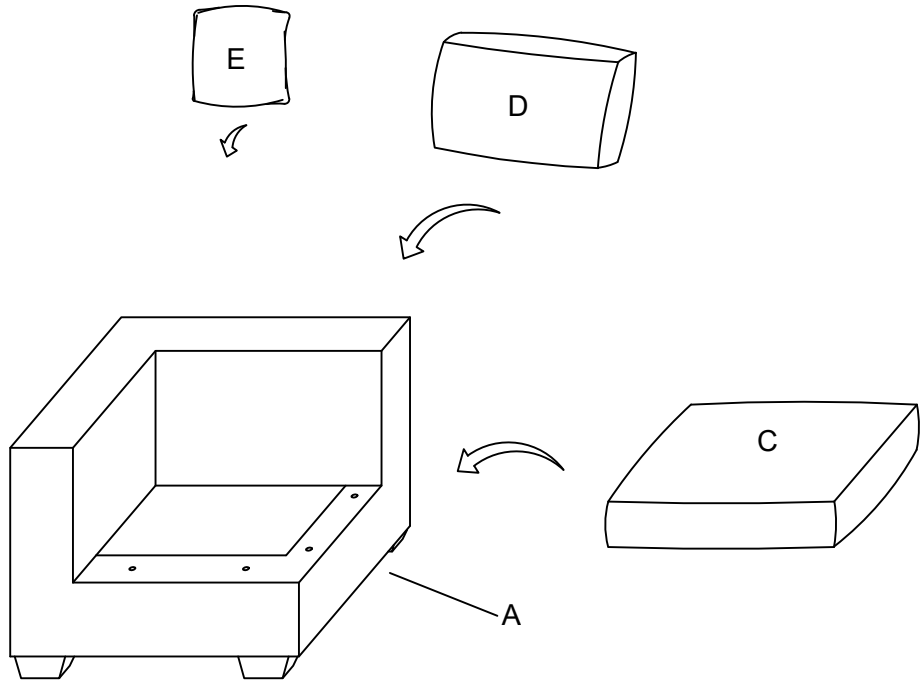

STEP 3B:

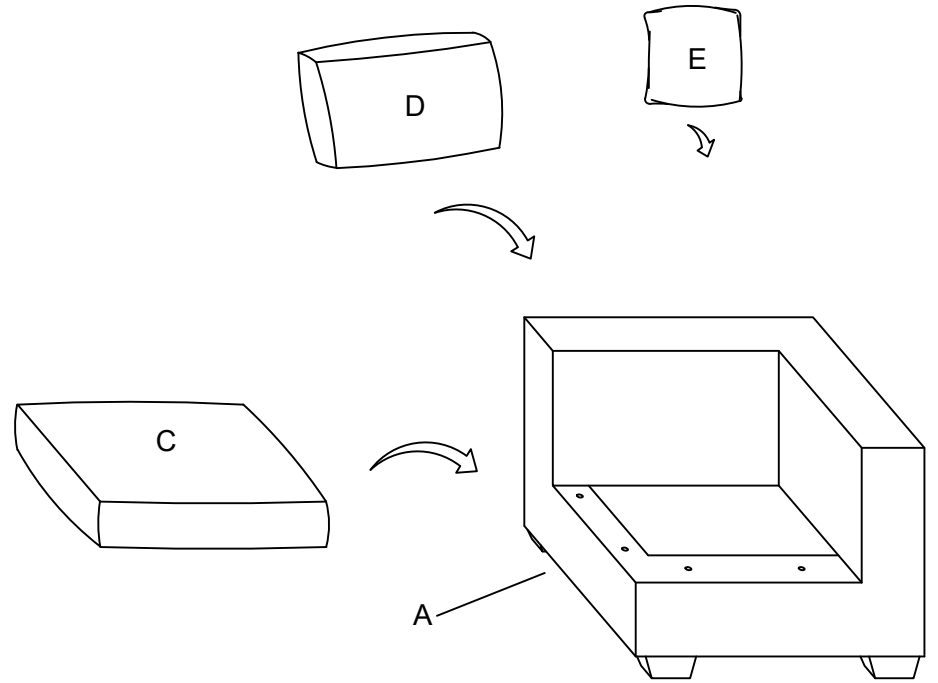

COMPLETED. #A

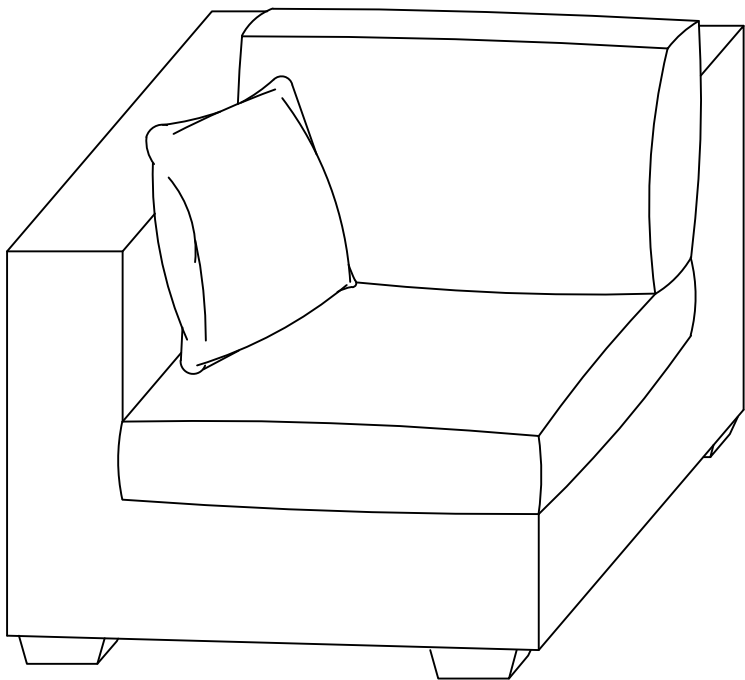

COMPLETED. #B

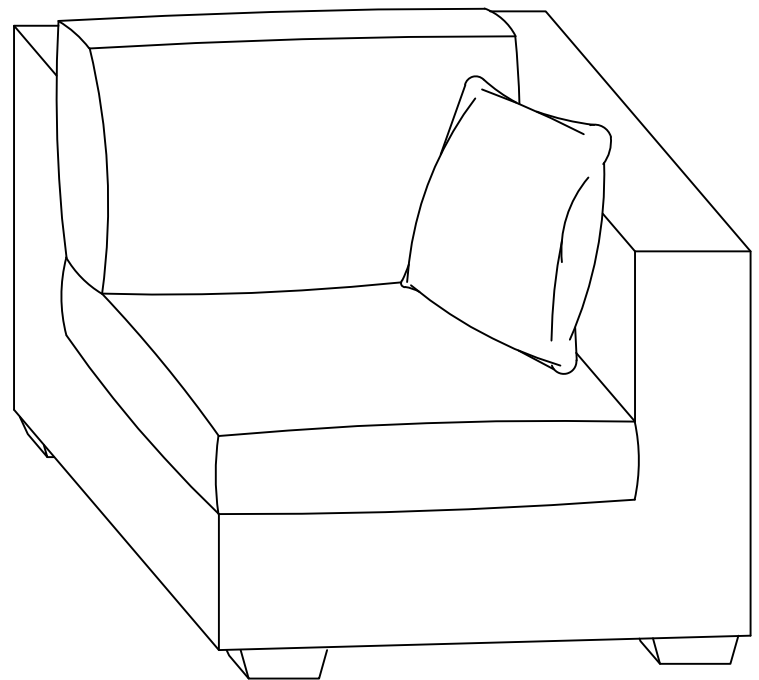

ASSEMBLING INSTRUCTIONS

ITEM NO: 8310NBE

SECTIONAL ASSEMBLY

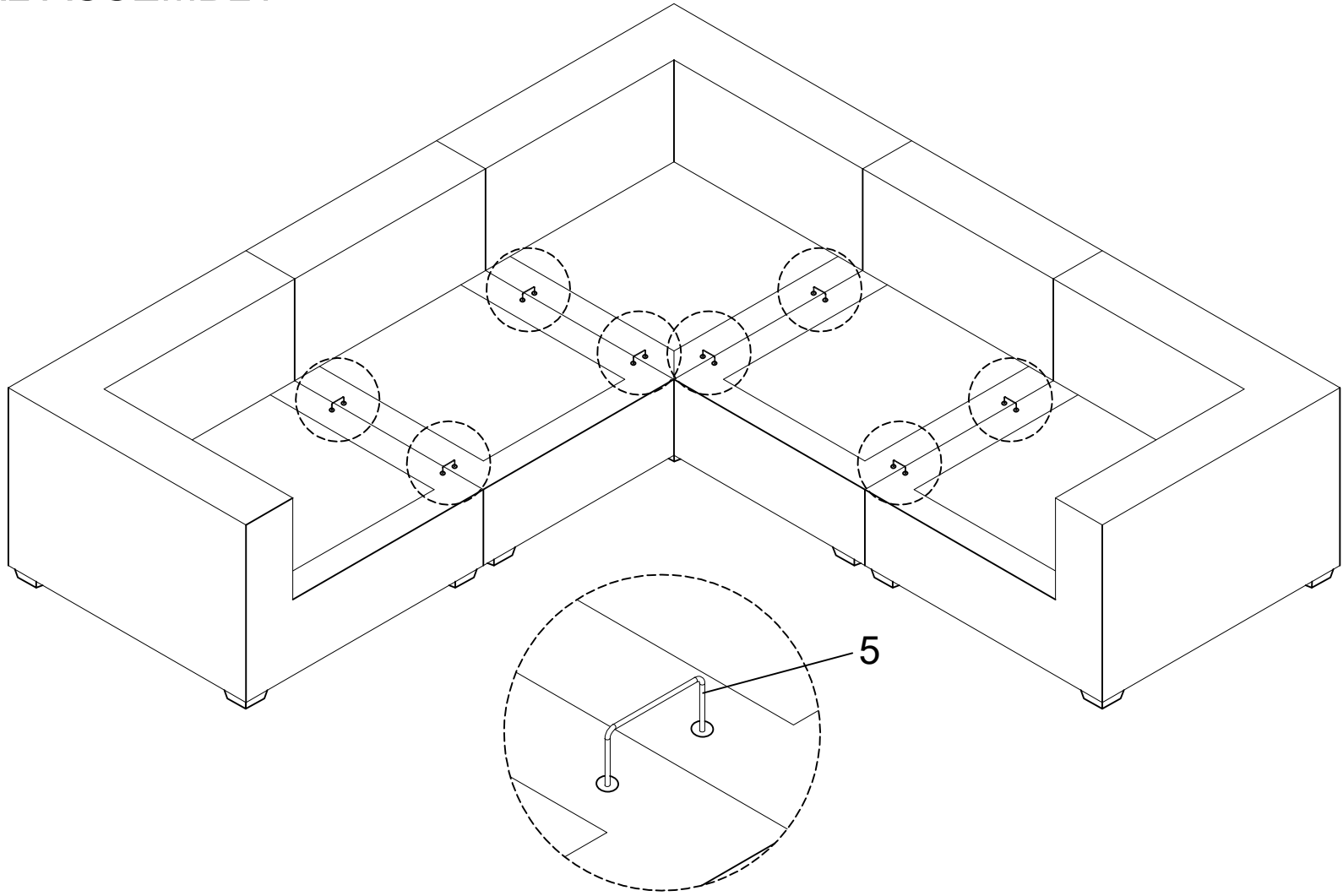

COMPLETED.

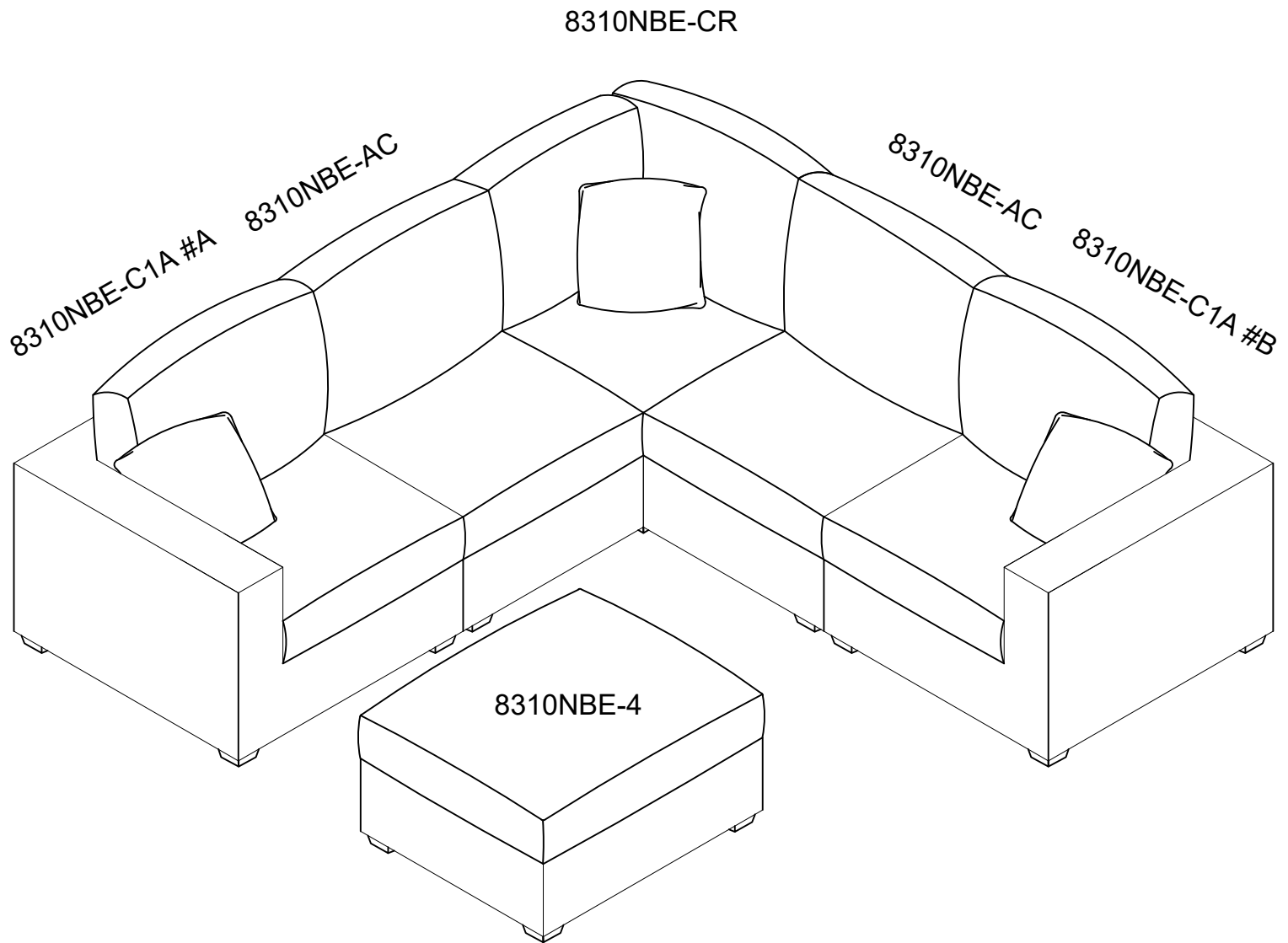

Care Instruction for Chenille Furniture:

In order to maintain the original appearance of your Chenille furniture, please follow below simple care procedures:

- Avoid exposing furniture directly to sunlight or heating and air conditioning outlets. Sunlight and or exposure to heating and air conditioning outlets will fade/damage Chenille.
- Vacuum or wipe with a soft cloth to remove dust.
- Hardware may loosen over time. Periodically check to make sure all connections are tight, Re-tighten if necessary

 For item use on wooden floor, hard surfaces or carpets, it is recommended to install protective pads under all legs and supports to avoid/prevent from damages/scratches and discoloration.