

ASSEMBLY INSTRUCTIONS / INSTRUCTIONS D' ASSEMBLAGE

5627NW-24
5627NBK-24
5627GY-24

COUNTER HEIGHT CHAIR
CHAISE HAUTEUR COMPTOIR

Thank you for purchasing this product. Please take time to read and follow the instructions below. Check that you have all parts and hardware before assembly. Parts apparently missing are often found in the packing materials. If you do not have all the parts listed, have your dealer contact us and they will be sent to you immediately.











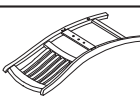

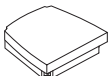

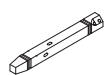
It is recommended to install protective pads under all legs and support to avoid damage or scratches when placing furniture on a wood floor or other hard surface, and to limit indentation and prevent discoloration if placing on carpet.

Merci d'avoir acheté ce produit. Veuillez lire et suivre les instructions ci - dessous. Vérifiez avant le montage que vous avez toutes les pièces et fixations. Les pièces qui semblent manquer se trouvent souvent dans les matériaux d'emballage. Si vous n'avez pas toutes les pièces de la liste, demandez à votre détaillant et nous les enverrons immédiatement.



Il est recommandé de placer des coussins protecteurs sous tous les pieds et toutes les bases des meubles pour éviter d'endommager ou d'égratigner les planchers en bois ou autres surface dures, et pour limiter l'empreinte et empêcher la décoloration quand les meubles reposent sur la moquette.

| PARTS LIST / LISTE DE PIÈCES | | | | HARDWARE LIST / LISTE DE QUINCAILLERIE FOR EACH CHAIR | | | |
|------------------------------|---|-------------------------------------|---|--|---|---|----|
| A |  | Chair Back / Dossier de chaise | 1 | 1 |  | Bolt / Boulon Ø1/4" x 38mm | 2 |
| B |  | Seat With Cushion / Siège | 1 | 2 |  | Bolt / Boulon Ø1/4" x 50mm | 4 |
| C |  | Front Legs (L/R) / Pied avant (L/R) | 2 | 3 |  | Bolt / Boulon Ø1/4" x 80mm | 4 |
| D |  | Front stretcher / Brancard avant | 1 | 4 |  | Lock Washer / Rondelle d'arrêt Ø1/4" | 10 |
| E |  | Left stretcher / Brancard (Gauche) | 1 | 5 |  | Flat Washer / Rondelle Plate Ø1/4" x Ø19mm | 10 |
| F |  | Right stretcher / Brancard (Droite) | 1 | 6 |  | Allen Key / Clé Allen 57mm x 4mm | 1 |
| | | | | 7 |  | Screw / Vis #8 x 45mm | 6 |

* Above hardware are packed in
5627NW / 5627NBK / 5627GY - 24 for assembly.
Le quincaillerie est dans 5627NW / 5627NBK / 5627GY - 24
pour l'assemblage.

STEP 1 / ÉTAPE 1

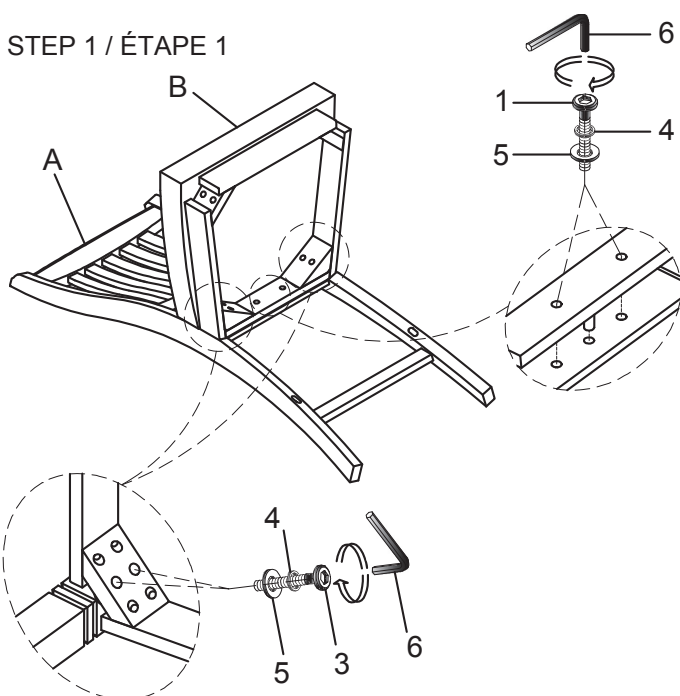

DO NOT TIGHTEN BOLTS UNTIL COMPLETELY ASSEMBLED.
NE PAS SERRER LES BOULONS JUSQU'À CE QUE LE MONTAGE
SOIT COMPLÈTMENT TERMINÉ.

STEP 2 / ÉTAPE 2

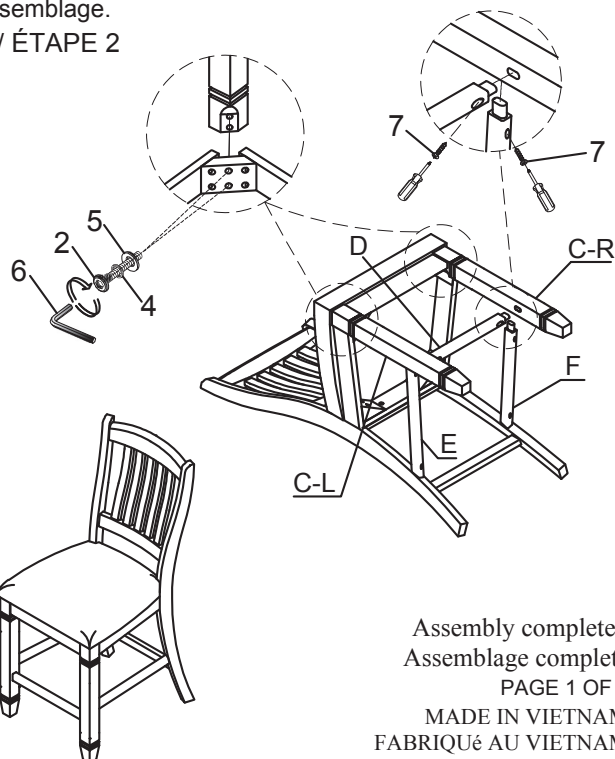

Assembly completed
Assemblage complété
PAGE 1 OF 1
MADE IN VIETNAM
FABRIQUÉ AU VIETNAM