







ITEM: 2259KGY/2259KW/2259KBR-1 (1/4) EASTERN KING / CAL KING SLEIGH HEADBOARD
 2259KGY/2259KW/2259KBR-2 (2/4) EASTERN KING / CAL KING FOOTBOARD W/2 STORAGE DRAWER
 2259GY/2259W/2259BR-3 (3/4) QUEEN/EASTERN KING RAILS

Thank you for purchasing this quality product. Be sure to check all packing material carefully for small parts which may have come loose inside the carton during shipment. Identify and count all parts and compare with the Parts List below.







! For items use on wooden floor, hard surfaces or carpets, it is recommended to Install protective pads under all legs and supports to avoid/ prevent from damages/ scratches and discoloration.

! Pour les articles Utilisés sur un plancher en bois, des surfaces dures ou tapis, il est recommandé d'installer des mordaches de protection sous tous les jambes et prend en charge pour éviter/empêcher de dommages/rajuures et la décoloration.

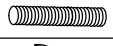
HARDWARE LIST OF FOOTBOARD
 HARDWARE PACK IS IN-2259KGY/2259KW/2259KBR-2





NO	DRAWING	DESCRIPTION	Q'TY
6		Φ5/16"*1-5/8" Bolt	6PCS
7		Φ5/16"Lock Washer	6PCS
8		Φ5/16"*19*2mm Flat Washer	6PCS
9		Φ5/16" Allen Key	1PC
10		#8*1" Screw	22PCS

HARDWARE LIST OF BED RAIL
 HARDWARE PACK IS IN-2259GY/2259W/2259BR-3

NO	DRAWING	DESCRIPTION	Q'TY
11		Φ5/16"*3-1/2"Hanger Bolt	8PCS
12		Φ50Arc Washer	8PCS
13		Φ5/16"*16*2mm Flat Washer	8PCS
14		Φ5/16"Lock Washer	8PCS
15		Φ5/16"Nut	8PCS
16		Φ5/16" Open Wrench	1PC

COMPONENT LIST		
A	HEADBOARD	1PC
B	HEADBOARD RSF LEG	1PC
B-1	HEADBOARD LSF LEG	1PC
C	FOOTBOARD	1PC
D	FOOTBOARD LEG	2PCS
E	SUPPORT LEG	3PCS
F	FOOTBOARD DRAWER	2PCS
G	SIDE RAIL	2PCS
H	SLAT (11 PCS)	1SET
I	SUPPORT LEG	5PCS

HARDWARE LIST OF HEADBOARD
 HARDWARE PACK IS IN-2259KGY/2259KW/2259KBR-1

NO	DRAWING	DESCRIPTION	Q'TY
1		Φ5/16"*2" Bolt	8PCS
2		Φ5/16"Lock Washer	8PCS
3		Φ5/16"*19*2mm Flat Washer	8PCS
4		Φ5/16" Allen Key	1PC
5		Φ22*13 Wood Plug	2PCS



ITEM: 2259KGY/2259KW/2259KBR-1 (1/4) EASTERN KING / CAL KING SLEIGH HEADBOARD
 2259KGY/2259KW/2259KBR-2 (2/4) EASTERN KING / CAL KING FOOTBOARD W/2 STORAGE DRAWER
 2259GY/2259W/2259BR-3 (3/4) QUEEN/EASTERN KING RAILS

Thank you for purchasing this quality product. Be sure to check all packing material carefully for small parts which may have come loose inside the carton during shipment. Identify and count all parts and compare with the Parts List below.

! For items use on wooden floor, hard surfaces or carpets, it is recommended to install protective pads under all legs and supports to avoid/ prevent from damages/ scratches and discoloration.

! Pour les articles Utilisés sur un plancher en bois, des surfaces dures ou tapis, il est recommandé d'installer des mordaches de protection sous tous les jambes et prend en charge pour éviter/empêcher de dommages/raures et la décoloration.

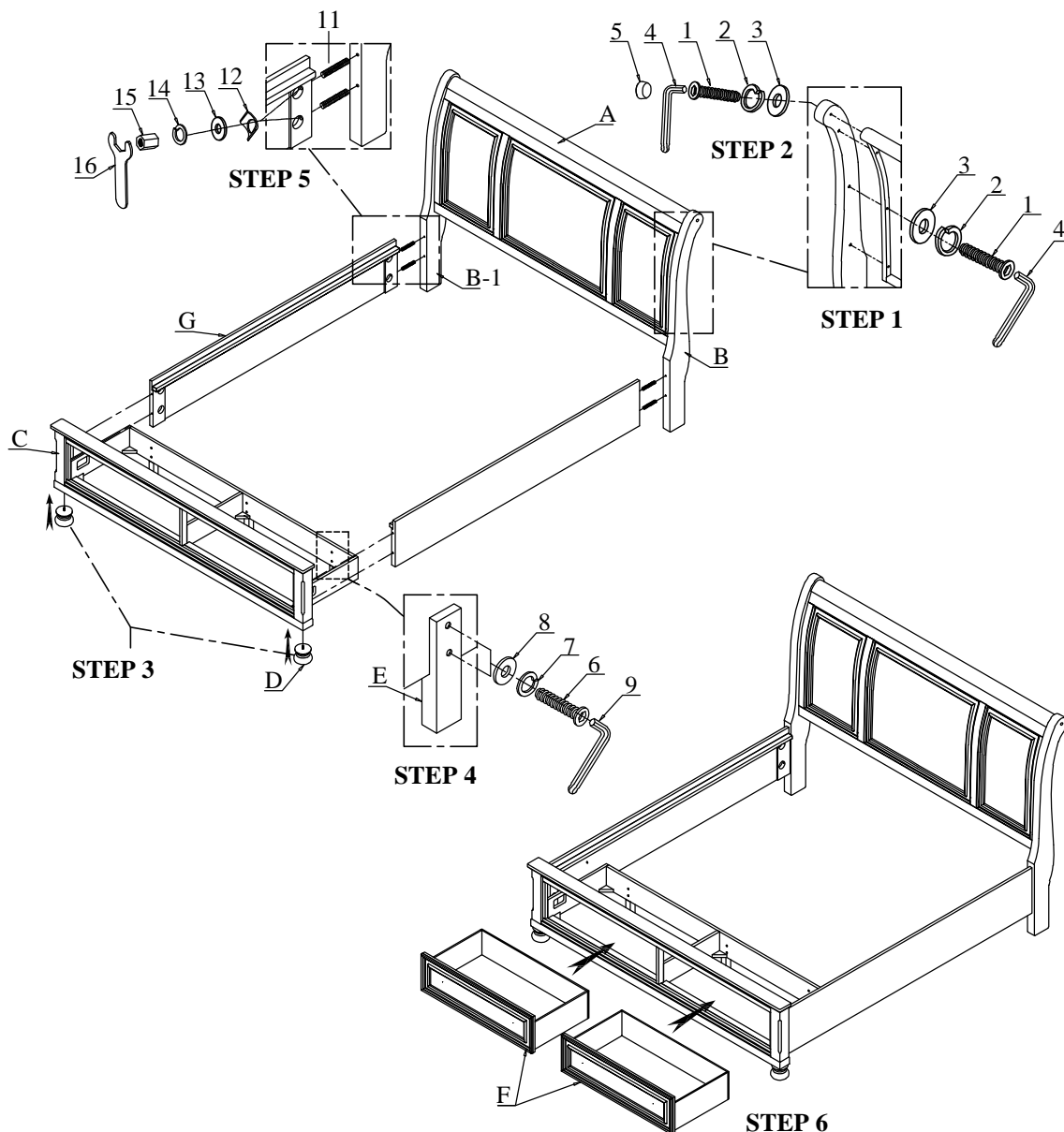



ITEM: 2259KGY/2259KW/2259KBR-1 (1/4) EASTERN KING / CAL KING SLEIGH HEADBOARD
2259KGY/2259KW/2259KBR-2 (2/4) EASTERN KING / CAL KING FOOTBOARD W/2 STORAGE DRAWER
2259GY/2259W/2259BR-3 (3/4) QUEEN/EASTERN KING RAILS

Thank you for purchasing this quality product. Be sure to check all packing material carefully for small parts which may have come loose inside the carton during shipment. Identify and count all parts and compare with the Parts List below.

! For items use on wooden floor, hard surfaces or carpets, it is recommended to install protective pads under all legs and supports to avoid/ prevent from damages/ scratches and discoloration.

! Pour les articles Utilisés sur un plancher en bois, des surfaces dures ou tapis, il est recommandé d'installer des mordaches de protection sous tous les jambes et prend en charge pour éviter/empêcher de dommages/raures et la décoloration.

