

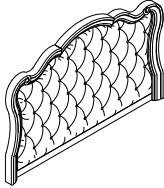

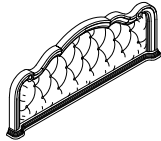

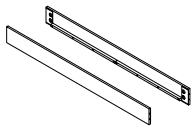

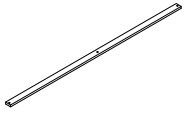

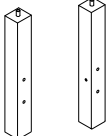
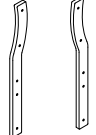

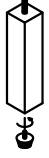
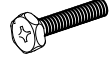
ASSEMBLY INSTRUCTION

Item#1682-1/1682-2/1682-3: Queen bed

<p>(A) Headboard</p>  <p>1pc</p>	<p>(B) Footboard</p>  <p>1pc</p>	<p>(C) Side rails</p>  <p>2pcs</p>	<p>(D) Slats</p>  <p>4pcs</p>	<p>(E) Post - Legs</p>  <p>LSF RSF</p> <p>2pcs</p>		
<p>(F) Support</p>  <p>LSF RSF</p> <p>2pcs</p>	<p>(G) Cross bar</p>  <p>1pc</p>	<p>(H) Bun Foot</p>  <p>2pcs</p>	<p>(I) Support legs</p>  <p>4pcs</p>	<p>(J) Bolt Φ5/16" x1-3/4"</p>  <p>12pcs</p>	<p>(K) Spring washer (Ø5/16")</p>  <p>12pcs</p>	<p>(L) Flat washer (Ø5/16"xØ19mm)</p>  <p>12pcs</p>
<p>(M) Threaded Bolt (Ø5/16"x3-1/2")</p>  <p>8pcs</p>	<p>(N) Half Round Washer (Ø5/16")</p>  <p>8pcs</p>	<p>(O) Hex Nut (Ø5/16")</p>  <p>8pcs</p>	<p>(P) Wrench (12mm)</p>  <p>1pc</p>	<p>(Q) Screw Ø8 x 1-1/4</p>  <p>8pcs</p>	<p>(R) Screwdriver (NOT INCLUDED)</p>  <p>1pc</p>	

Note: Hardware pack is in 1682-1

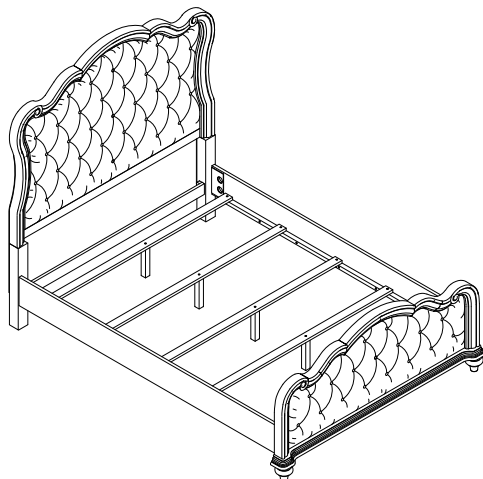

This page lists all the contents included in the box. Please take time to identify the hardware as well as the individual components to this product. As you unpack and prepare for assembly, place the contents on a carpeted or padded area to protect them from damage.

! For items use on wooden floor, hard surfaces or carpets, it is recommended to install protective pads under all legs and supports to avoid/prevent from damages/scratches and discoloration.

Made in Vietnam

1

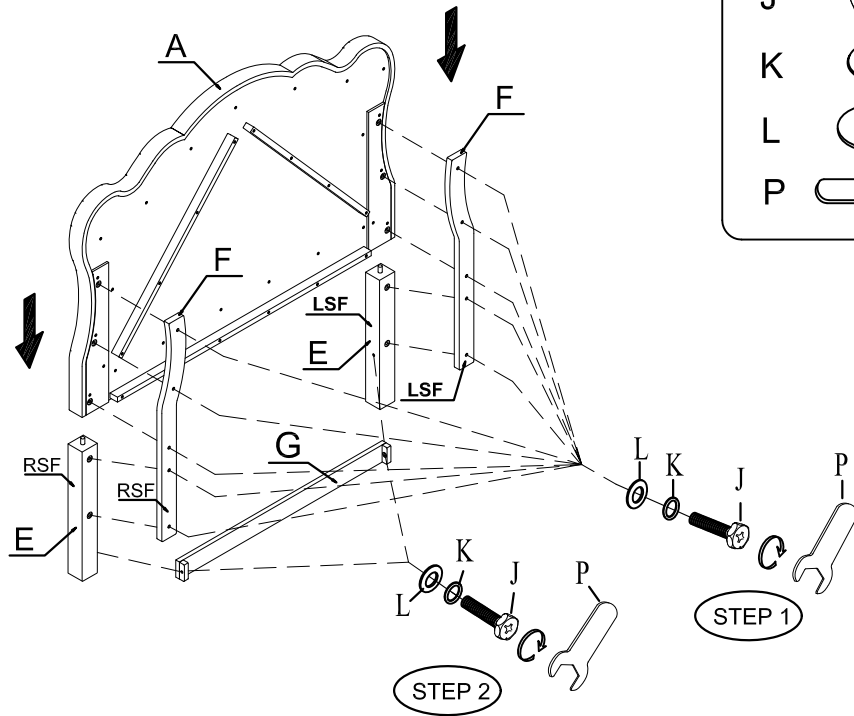

2

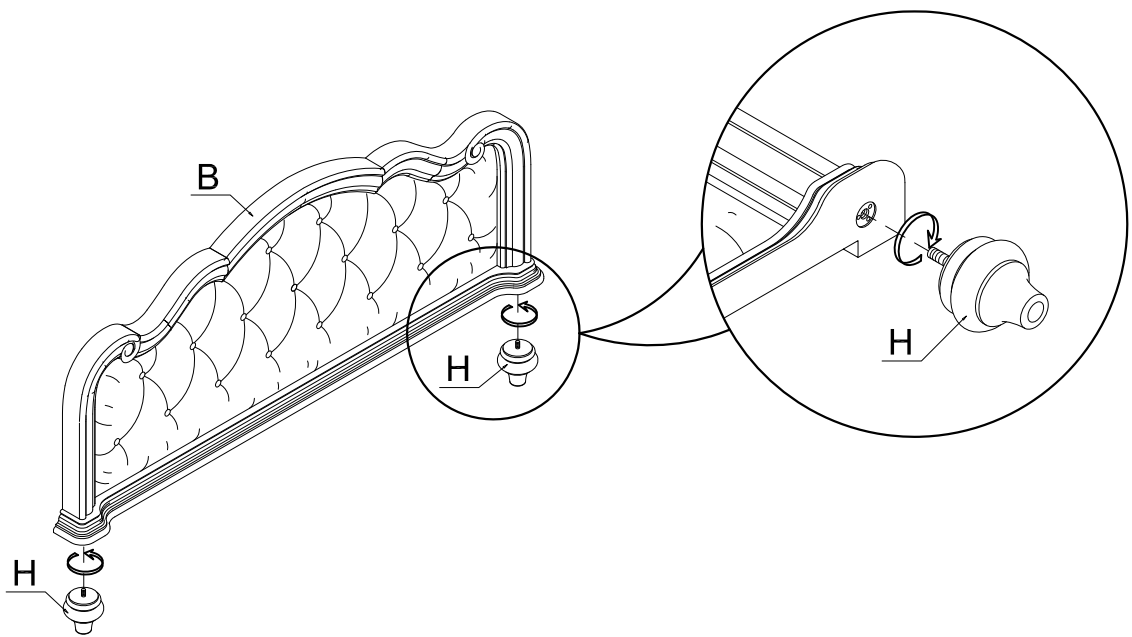

Made in Vietnam

3

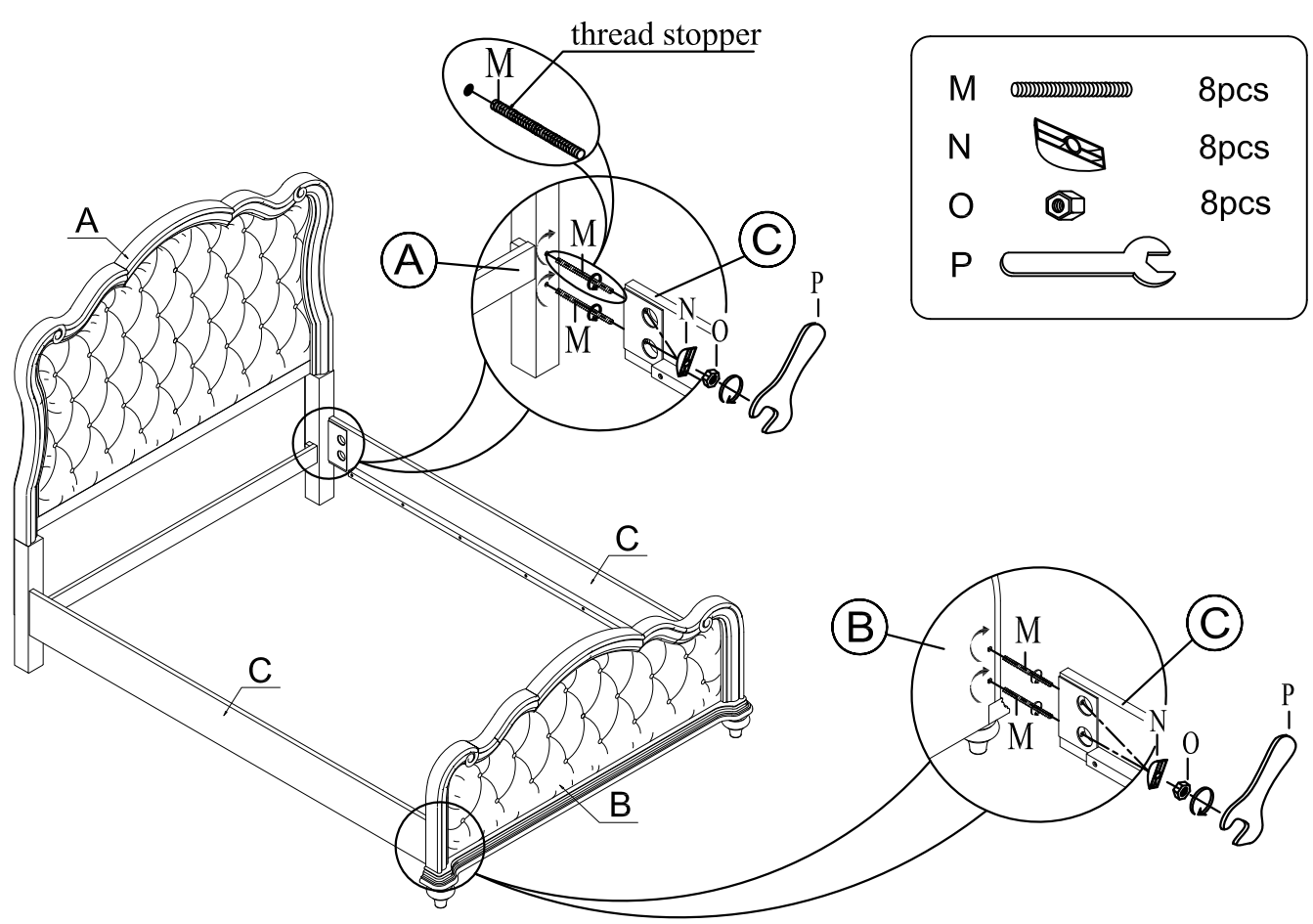

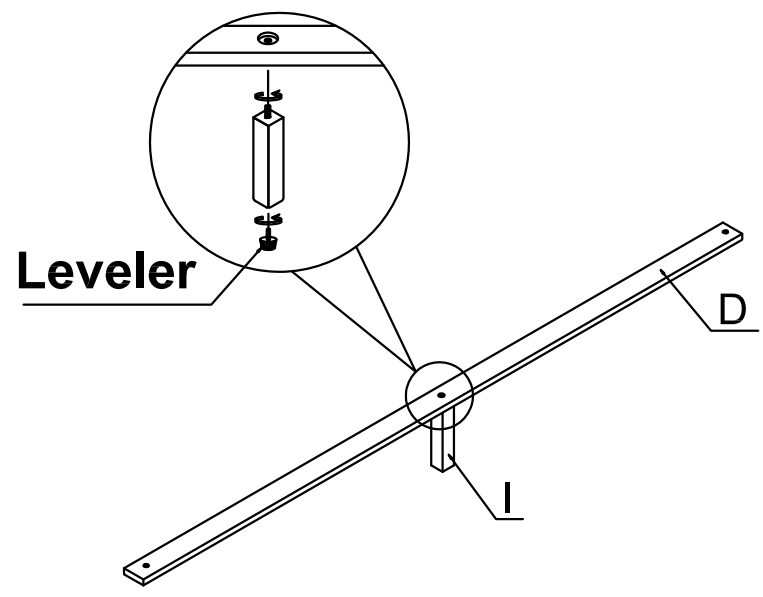

4



← X4

Made in Vietnam

5

- | | | |
|---|---|------|
| Q |  | 8pcs |
| R |  | |

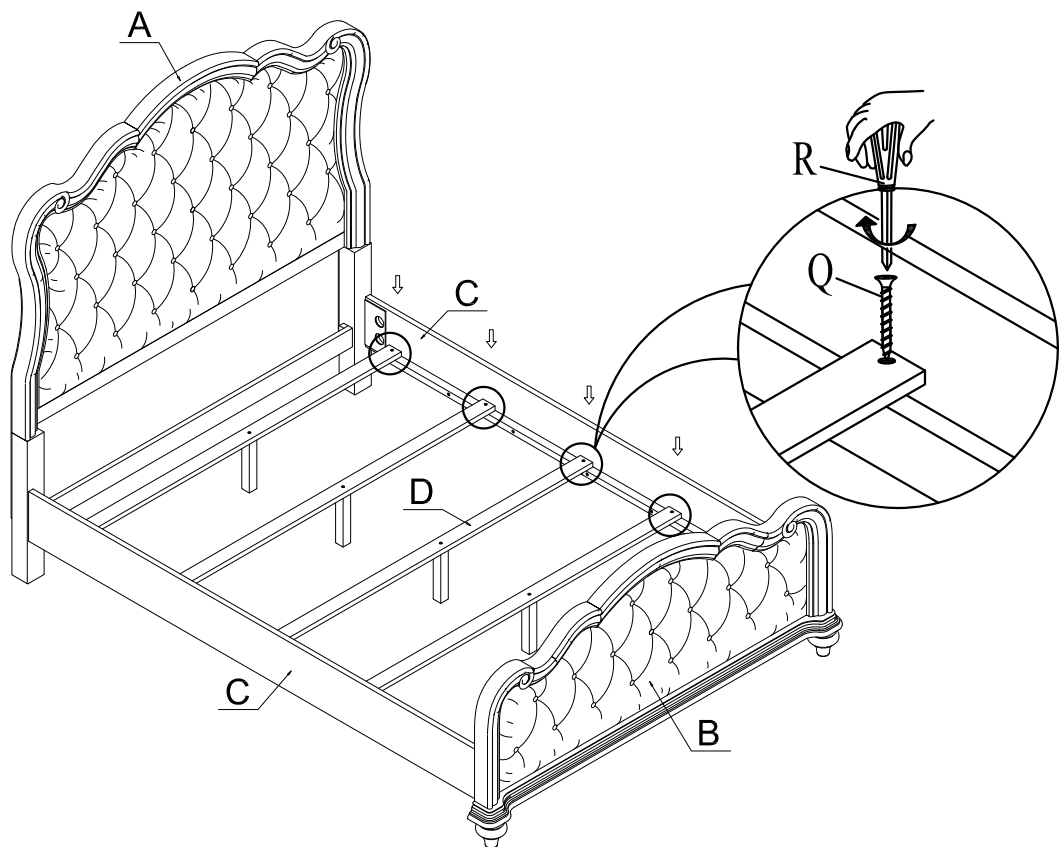

Cleaning & Care

Treat surface with care. Clean surfaces with a dry or damp soft cloth. Do not use abrasive cleaners. Hardware may loosen over time. Periodically check that all connections are tight.

Made in Vietnam